



PROFI[®]
BUS

Basic
Slide Set



Technology
Life Cycle
Management
Organization/
Support
Case Studies

- The slide set „PROFIBUS - Easy to use“ provides compact information about technology, operation, application and benefits of PROFIBUS.
- For easy handling, the slide set is structured in „tasks“. Click  to find the list of tasks.
- Additional information is available to many pages under (top left) 
- For in-depth information see „Literature List“ under 

What is **PROFIBUS?**

A
short
introduction



■ Fieldbus-based automation standard

- PROFIBUS is the fieldbus-based automation standard of PROFIBUS & PROFINET International (PI), the largest automation community in the world.
- PROFIBUS links controllers or control systems to several decentralized field devices (sensors and actuators) via a single cable.

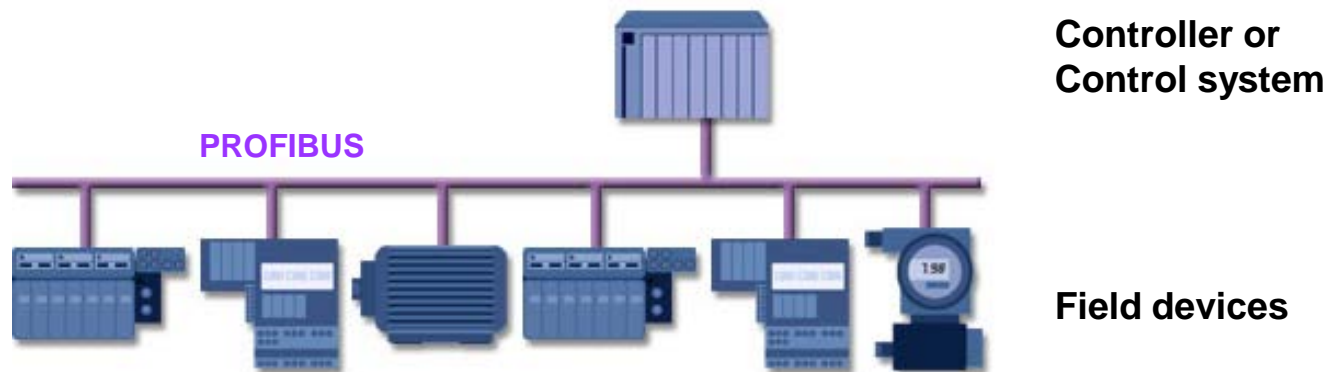

■ One protocol

- PROFIBUS supports factory and process automation as well as drive applications with the same consistent communication protocol named PROFIBUS DP.
- This enables mixed (hybrid) applications, where continuously running processes, e.g. mixing or drying, are combined with discrete functions such as identifying, conveying or packing.

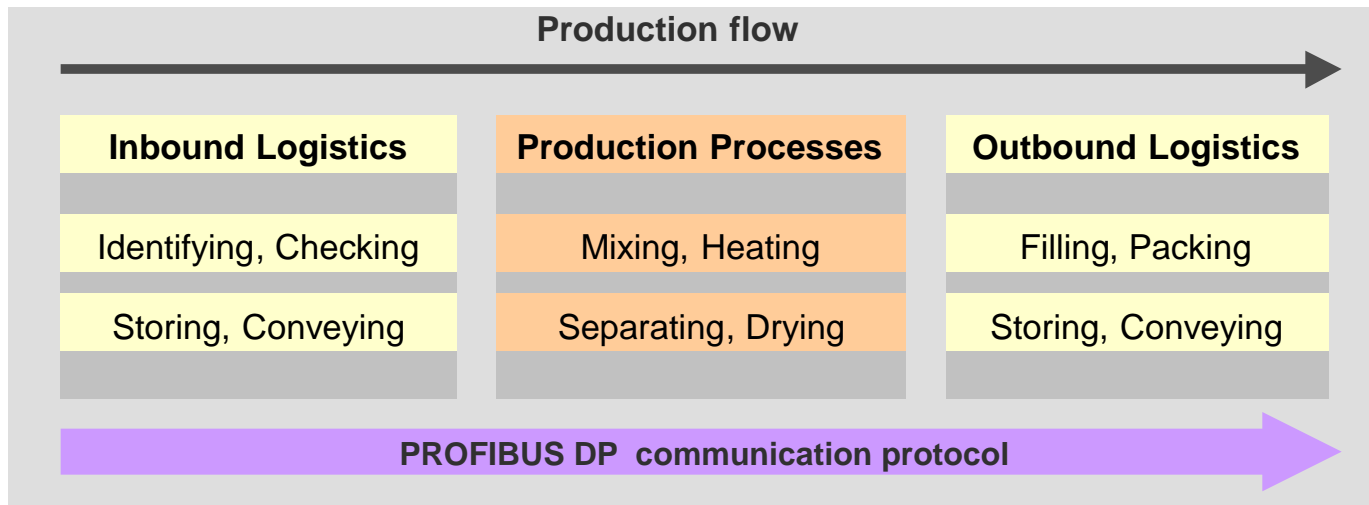

■ Part of a multi-level network

- PROFIBUS enables consistent data exchange with higher-ranking communication systems.
- PROFIBUS is part of the communication network between field level and enterprise level, or even going up to the internet.

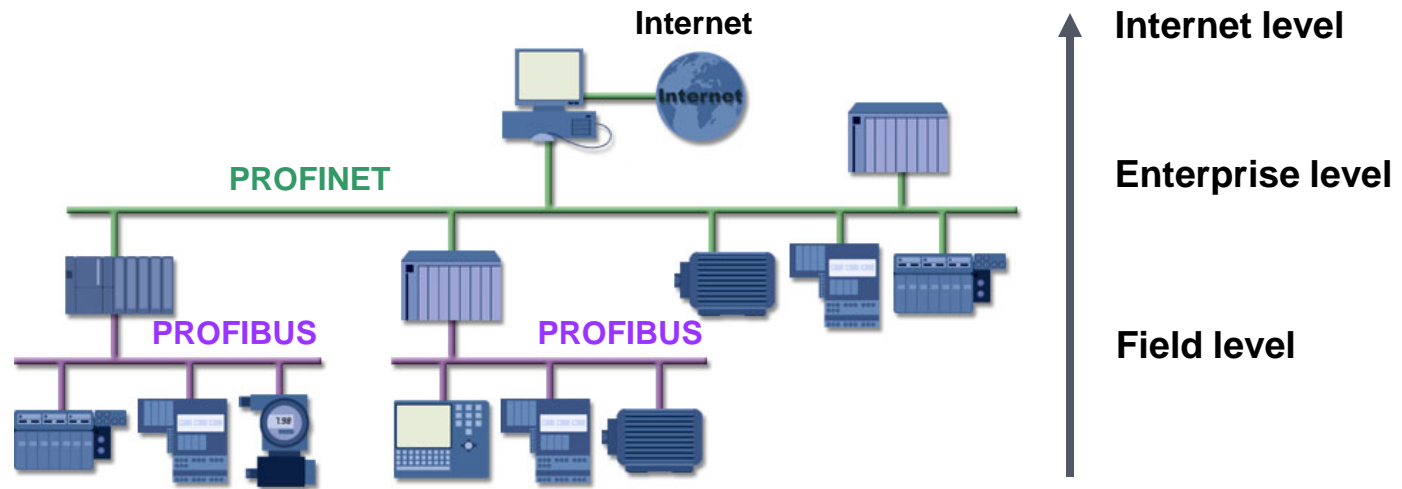

■ PROFIBUS is a modular structured system

- PROFIBUS modules are arranged according to their functionalities: (Transmission, Communication, Application, Integration).
- A PROFIBUS application for a certain industry sector (solution) is implemented by combining suitable modules: >> *next slide*.

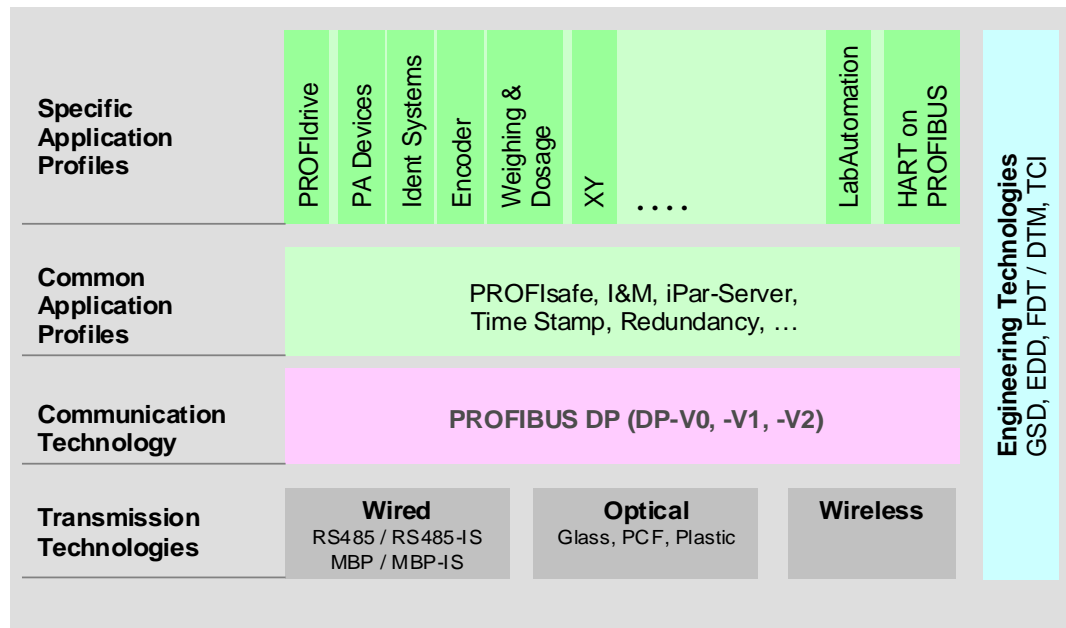

PROFIBUS solutions for various industry sectors

Market Segment	Process Automation Ex / non-Ex areas	Factory Automation	Motion Control	Safety Application
PROFIBUS Solution (Common term)	PROFIBUS PA	PROFIBUS DP	PROFIdrive	Safety
Application Profile	PA Devices (and others)	e.g. Ident Systems	PROFIdrive	PROFIsafe
Communication Technology	PROFIBUS DP	PROFIBUS DP	PROFIBUS DP	PROFIBUS DP
Transmission Technology	MBP / MBP-IS RS 485 / 485-IS	RS 485	RS 485	RS 485 MBP-IS



Factory automation

- Vehicle manufacture
- Bottling plants
- Warehousing systems
- Switchgear
- Hollow glass production



Process automation

- Chemical industry
- Petrochemical industry
- Paper and textile industry
- Foodstuffs
- Power stations
- Sewage plants



Drive technology

- Machine tools
- Packaging machines
- Pressing plants
- Paper production



Safety applications

- Vehicle assembly
- Machine tool building



■ PROFIBUS DP and PROFIBUS PA

- **PROFIBUS DP** (Decentralized Periphery) is mainly used for high speed input/output devices and to link intelligent devices such as drives. It can use different physical layers such as RS-485, wireless or fiber optics. RS-485 is the most common one.

- **PROFIBUS PA** (Process Automation) refers to the following additional features:
 - Bus powered by using the Manchester encoded Bus Powered (MBP) physical layer according to IEC 61158-2
 - Intrinsically safe design
 - Configuration over the bus
 - Device profile



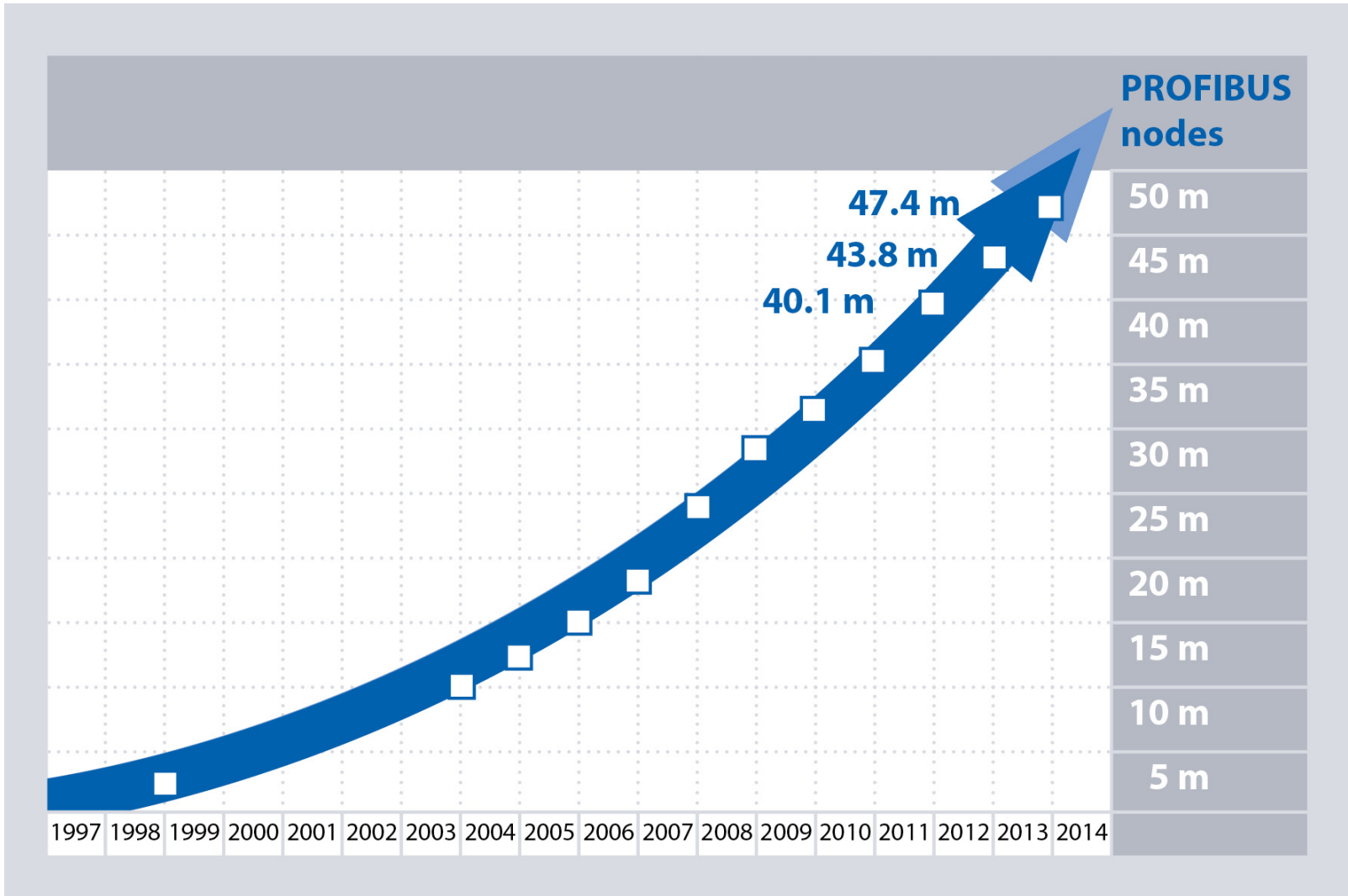

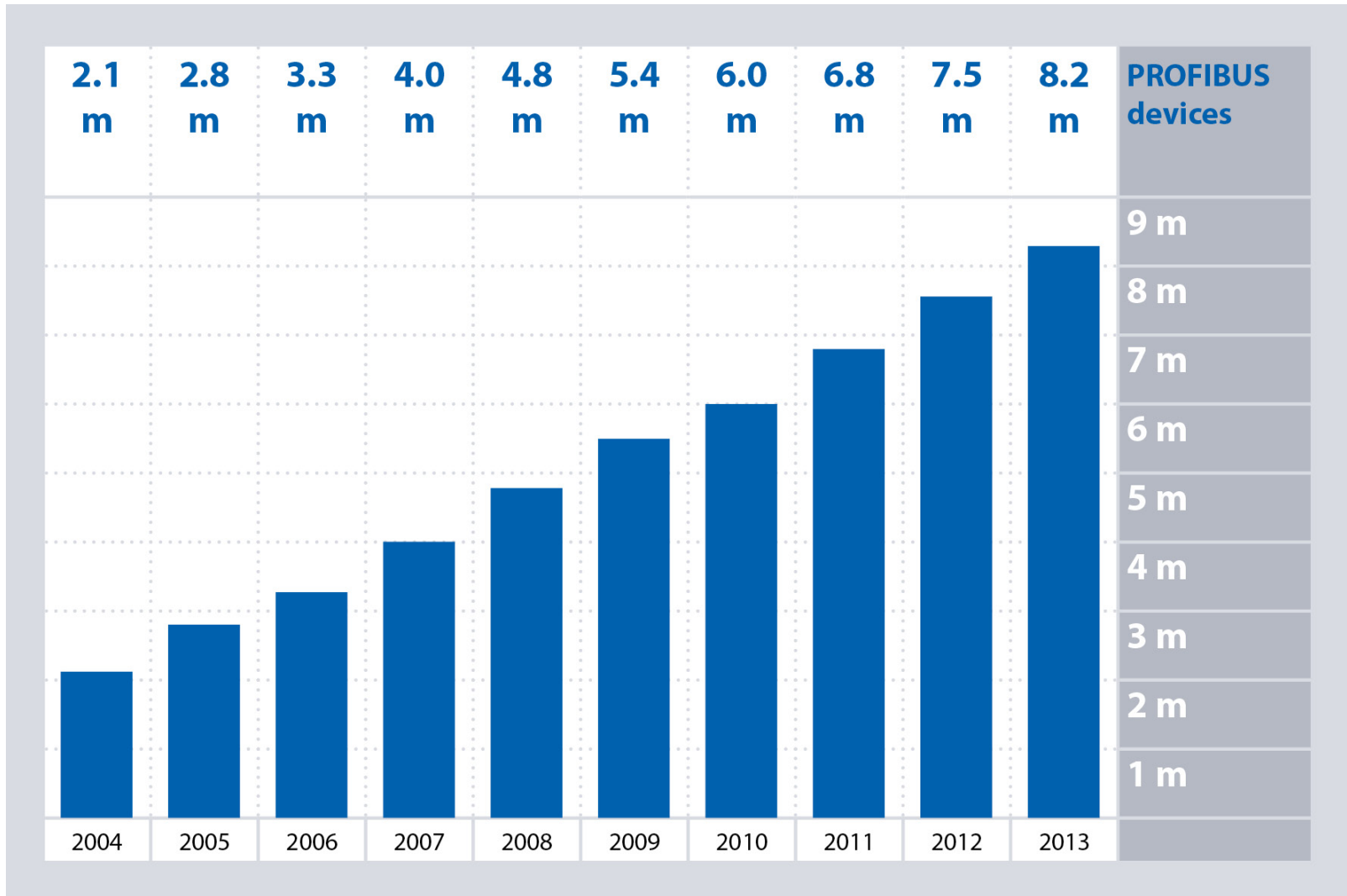

■ More than 2500 „PROFIBUS Devices“ are available in the PROFIBUS product guide



Technology

Fieldbus talks digital

Diagnosis & Asset Manag.

PROFIsafe

Communication Protocol

Device integration

PROFINET in PA

Transmission technologies

Components and topology

Application Profiles

Explosion protection

Life Cycle Management

How to design PB?

How to install PB?

How to manage field devices?

How to use diagnostics?

How to benefit from PROFIBUS?

Organisation / Support

PROFIBUS & PROFINET International (PI)

Implementation and certification

Standardization

Literature

Success Stories

Process and manufacturing industries

Safety applications

Drive applications



Fieldbus talks digital

Stepping
from analog
to digital
communication
means a major
paradigm shift



■ Non-fieldbus system: One way communications

- Tasks of field devices and control system are clearly separated
- Only analog values (measured data) are transferred
- Only a one-way communication exists

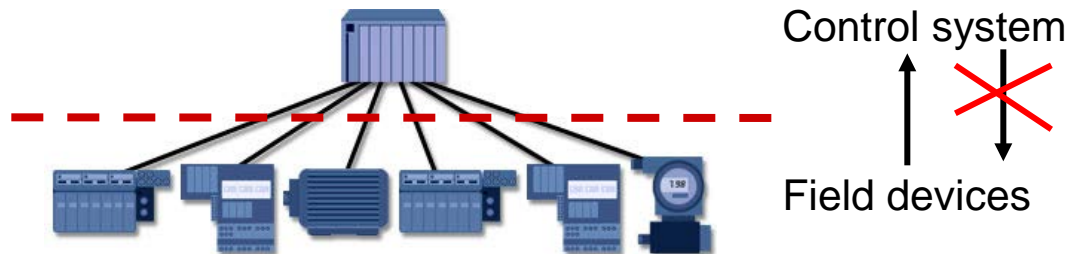

■ Fieldbus system: Digital and two-way communications

- Field devices are an integral part of a control system
- Digital values are transferred by a two-way communication link
- A digital dialogue exists between controller and field devices
- Field devices adapt a new role; this is a major paradigm shift

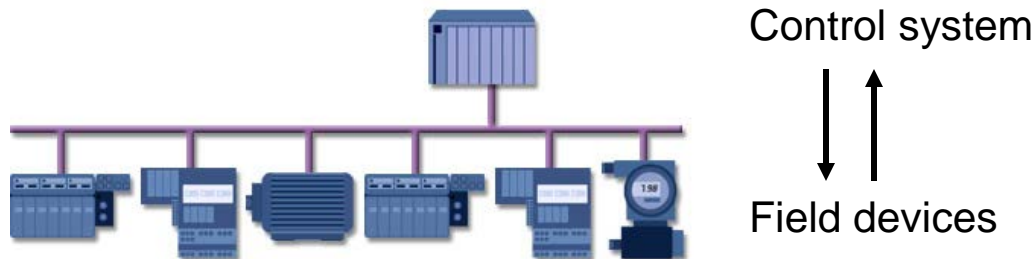

■ Benefits of using a digital fieldbus (PROFIBUS)

■ Plant Asset Management is enabled

Information from process and devices are available in the controller.

■ Construction and installation is optimized

100s of separate wires are reduced down to just one cable.

■ Commissioning is fastened

The end user can scale the devices from one central location.

■ Accuracy is increased

No need for digital/analogue conversion (in the device) and analogue/digital conversion (in the controller). >> higher accuracy

■ Process variables can be trusted

The diagnostic information and status bytes tell the user if they can trust the process variable or not.



Communication Protocol PROFIBUS DP

One single,
consistent
protocol for
all applications
in factory and
process
automation



PROFIBUS DP communication protocol

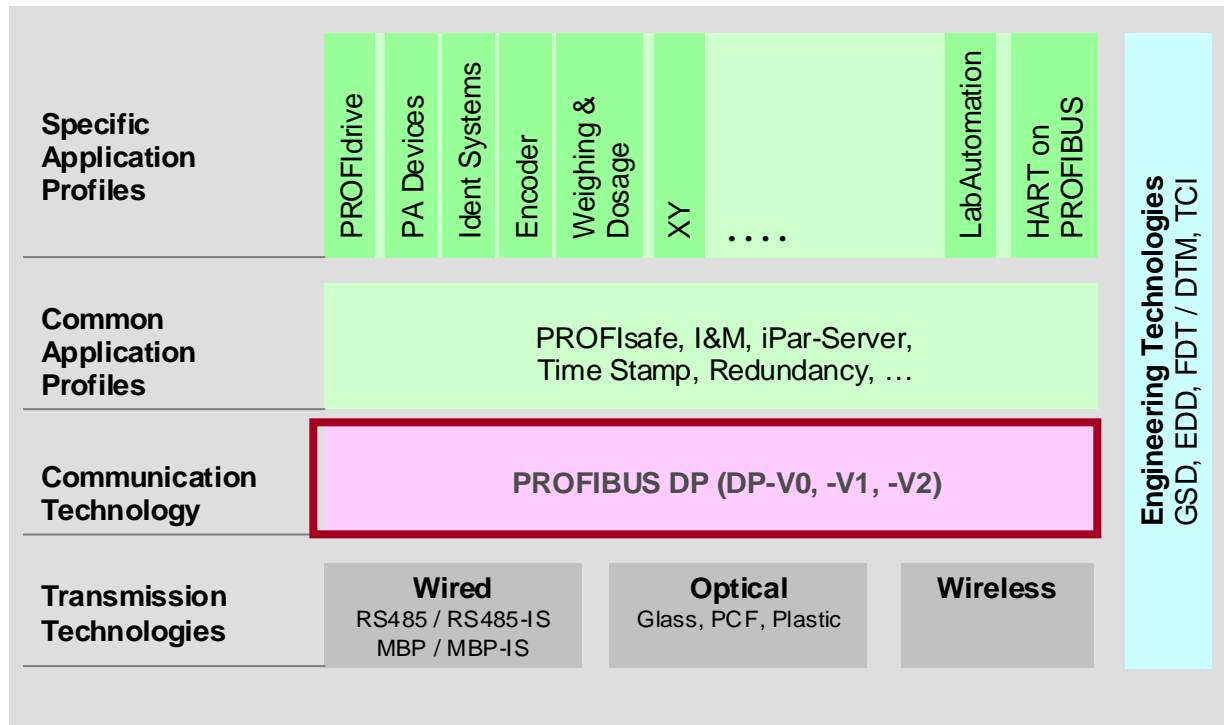

- PROFIBUS uses a single, open communication protocol (PROFIBUS DP, **D**ecentralized **P**eriphery) for all applications

- The protocol uses the “Master-Slave” model: One device (master) controls one or more other devices (slaves).

- The protocol uses the “Token Passing” model: The “token” is transmitted across the network; the station in possession of the token controls the access to the network.

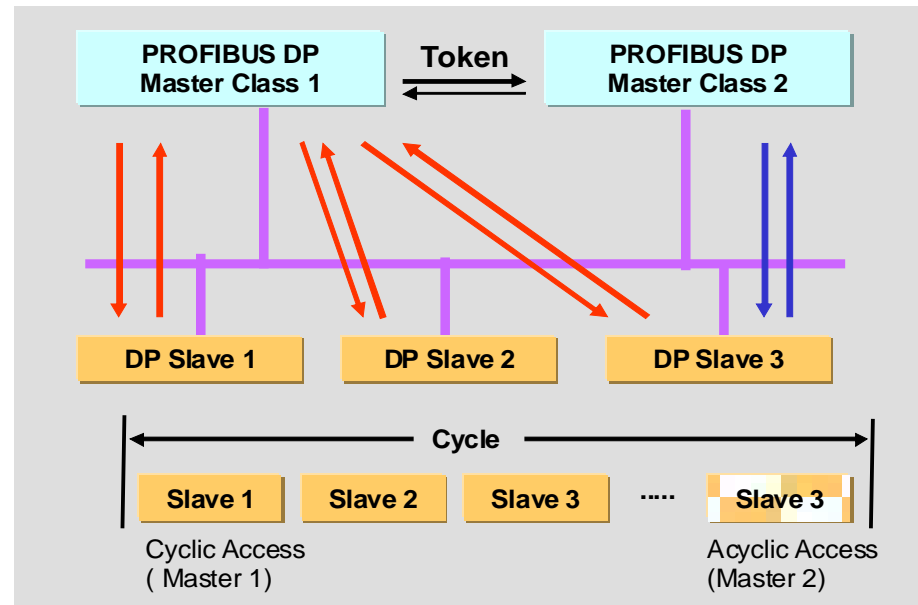

■ PROFIBUS DP exists in three versions:

- **DP-V0:** Overall command structure, cyclic data exchange
- **DP-V1:** Extension by acyclic data exchange et al.
- **DP-V2:** Further extension by time stamp, clock synchronization et al.

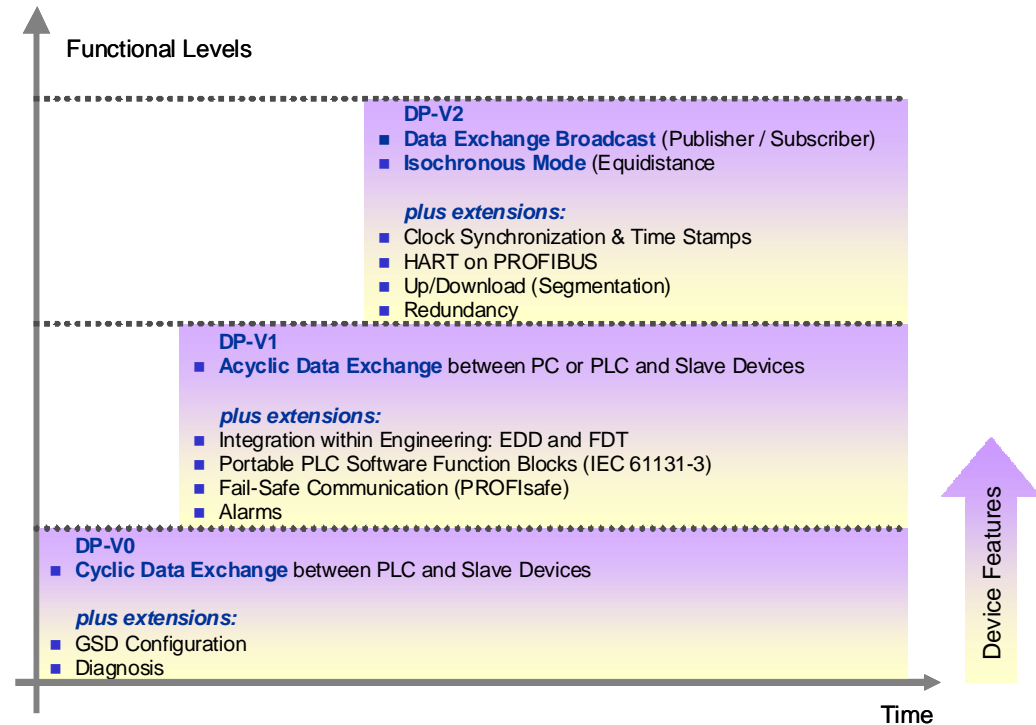

■ One single protocol for all applications

- PROFIBUS DP carries all communications between a DCS or controller and individual field devices.

- Factory devices and certain process devices are *directly* connected to PROFIBUS DP.

1

- Process automation (PA) devices, grouped in “PA segments”, are connected to PROFIBUS DP via coupler or links.

2

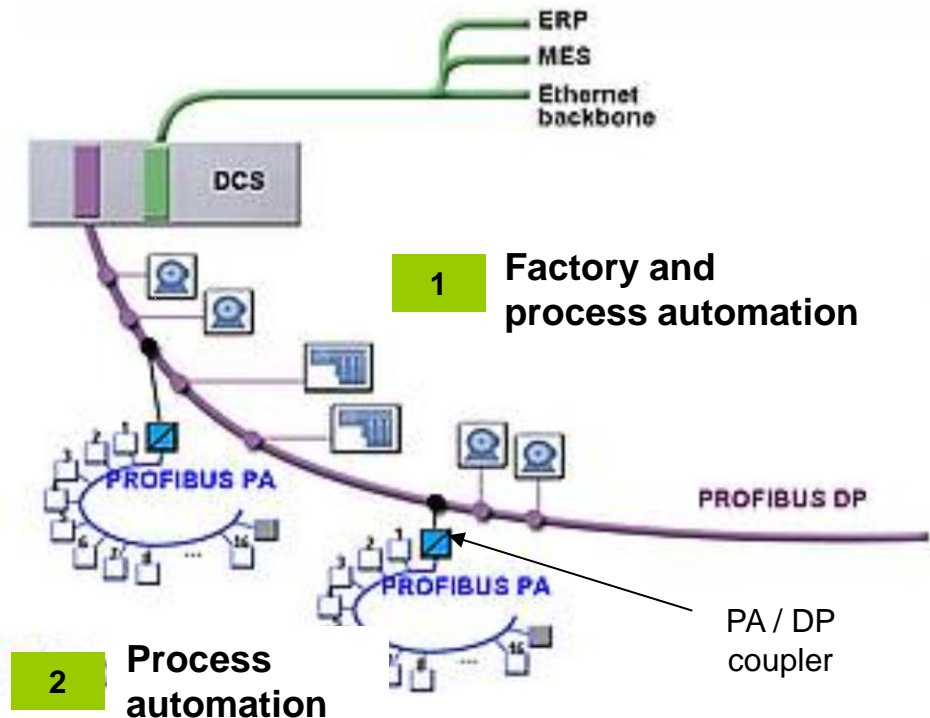

Transmission Technologies

RS 485
MBP
Optical
Wireless



PROFIBUS supports different transmission technologies

Wired, Optical, and Wireless

Specific Application Profiles	PROFIdrive PA Devices Ident Systems Encoder Weighing & Dosage XY LabAutomation HART on PROFIBUS			
Common Application Profiles	PROFIsafe, I&M, iPar-Server, Time Stamp, Redundancy, ...			
Communication Technology	PROFIBUS DP (DP-V0, -V1, -V2)			
Transmission Technologies	<table border="1"> <tr> <td>Wired RS485 / RS485-IS MBP / MBP-IS</td> <td>Optical Glass, PCF, Plastic</td> <td>Wireless</td> </tr> </table>	Wired RS485 / RS485-IS MBP / MBP-IS	Optical Glass, PCF, Plastic	Wireless
Wired RS485 / RS485-IS MBP / MBP-IS	Optical Glass, PCF, Plastic	Wireless		
Engineering Technologies GSD, EDD, FDT / DTM, TCI				



■ Wired transmission (1)

- RS 485; MBP
- RS 485-IS; MBP-IS (Intrinsically Safe)

	RS - 485 PROFIBUS DP	MBP PROFIBUS PA	MBP- IS PROFIBUS PA
Baud rate	9.6 ... 12.000 kBit/s	31.25 kBit/sec	31.25 kBit/sec
Devices/segment (max.)	32	32	32
Devices/segment (typic.)		14 ... 20	4 ... 6
Cable length max.	1200	1900 m	1000 m
Spur line length max.		120 m	60 m



■ Wired transmission (2)

■ MBP transmission technology

Fieldbus standard IEC 61158-2 for MBP transmission technology

Up to 32 nodes in one segment

Data transmission rate 31.25 Kbit/s

Per field device: Min. working voltage 9 V DC
Min. current consumption 10 mA

Transmission of digital communication signal in zero-mean Manchester II coding (MBP) through ± 9 mA amplitude

Signal transmission and remote power supply using twisted-pair cable

Fieldbus cable type A

Connection of field devices via stubs (spur) to a main cable (trunk) for trouble-free disconnection of devices without affecting other nodes

Max. total length of main cable, including all stubs, is 1900 m



■ Optical transmission

- Various types of fiberoptic cables are supported.
- Typical topology structures are star and ring, linear structures are also possible.
- The implementation of a fiberoptic cable network involves the use of electrooptical converters.

Fiber type	Core diameter [μm]	Transmission range
Multi-mode glass fiber	62,5 / 125	2 - 3 km
Single-mode glass fiber	9 / 125	> 15 km
Plastic fiber	980 / 1000	Up to 100 m
HCS® fiber	200 / 230	Approx. 500 m



■ Wireless transmission

- PROFIBUS & PROFINET International did not specify its own wireless solution.
- Numerous wireless solutions are available for PROFIBUS from different vendors using gateways to translate the electric signals into electromagnetic waves.

See the product guide on the PROFIBUS website and search for wireless. Various types of fiberoptic cables are supported.



PROFIBUS Application Profiles

Application
profiles
greatly
improve
feasibility of
PROFIBUS



Application Profiles

To ensure correct interaction between the bus nodes of an automation system, the basic functions and services of the nodes must match. This uniformity is achieved through the use of application profiles.

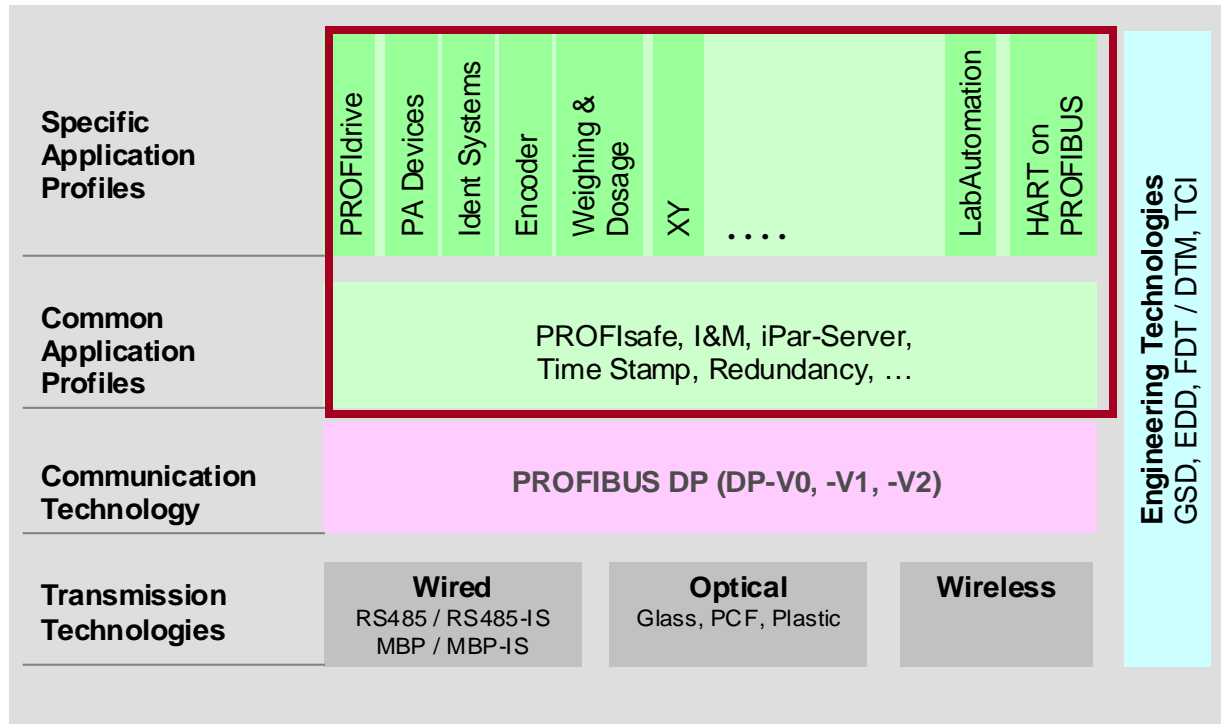

- PROFIBUS Application Profiles (APs) are vendor-independent specifications implemented into PROFIBUS devices to enable uniform behaviour of devices from different manufacturers.
 - **General cross-device-class** behavior
(e.g. in safety or redundancy applications; identification data)
 - **Specific device-class-specific** behavior
(e.g. process devices, drives, identification devices)
 - **Specific Industry-specific** behavior
(e.g. rail vehicles, laboratory devices)
- Application profiles are specified by PI working groups and are available (currently 17) from PI.



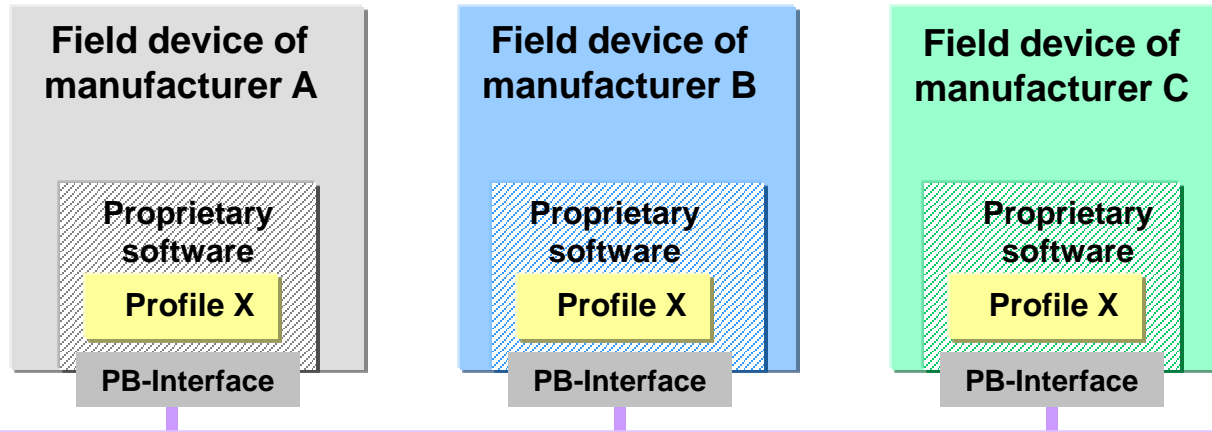

Implementation of an identical profile (X) in all devices allows consistent behavior and interoperability of the devices at the bus.



■ PROFIBUS profiles (selection out of a total of 17):

■ PROFIdrive

specifies the device behavior and access behavior to data for variable speed electric drives.

■ Ident Systems

specifies the communication between identification devices such as barcode reader or transponder.

Continued next page...



■ PROFIBUS profiles continued:

■ PA Devices (“PA”)

specifies the properties and behavior of process automation devices (transmitter, pumps, analyzer, ...).

Read more: Two slides further

■ I&M

specifies a concept for identification of PROFIBUS devices and internet access to device-specific information.

■ HART on PROFIBUS

specifies the integration of HART devices in PROFIBUS systems.

■ PROFIsafe

defines safe communication of safety-related devices with safety controllers via PROFIBUS.



■ PROFIBUS profiles continued:

■ Encoder

defines the connection of rotary, angular, and linear encoders with single-turn and multi-turn resolution.

■ Remote IO

defines the interchangeability of remote IO devices in process automation.



■ PA profile V 3.02 provides mechanisms and functions for easy management of field devices and diagnostics

When a field device has to be replaced, the new device (with possibly advanced technology) automatically determines and assumes the tasks of the predecessor model without any interruption of the process.

[Read details under “How to manage field devices?”.](#)

Additional profile 3.02 specifications include mandatory mapping of specific diagnostic information of field devices onto standardised categories and faster transfer of field device data.

[Read more details under “How to use diagnostics?” and “Diagnosis & Asset Management”.](#)



Diagnosis & Asset Management

PROFIBUS
provides
excellent
support to
Asset
Management



■ **Assets**

Any item of economic value such as cash, inventory, buildings, machines, office or plant equipment, patents, know how etc.

■ **Plant Assets**

Virtual and physical assets applicable to manufacturing activities (controllers, field devices, drives etc.).

■ **Plant Asset Management**

All measures to monitor critical plant assets for optimal use, reducing the risk of failures while ensuring functionality and availability.

■ **PROFIBUS diagnosis capabilities**

Support plant asset management extensively.



- Unlike conventional communication systems, PROFIBUS allows a detailed “view into field devices”.

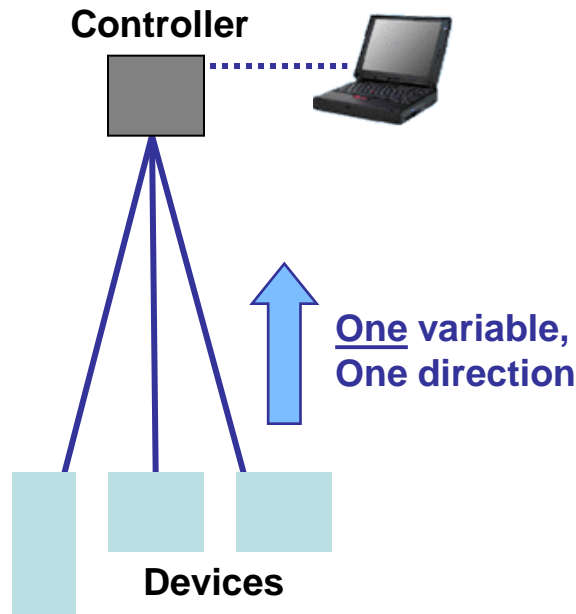

Conventional system

Very limited system view,
device details are „invisible“.

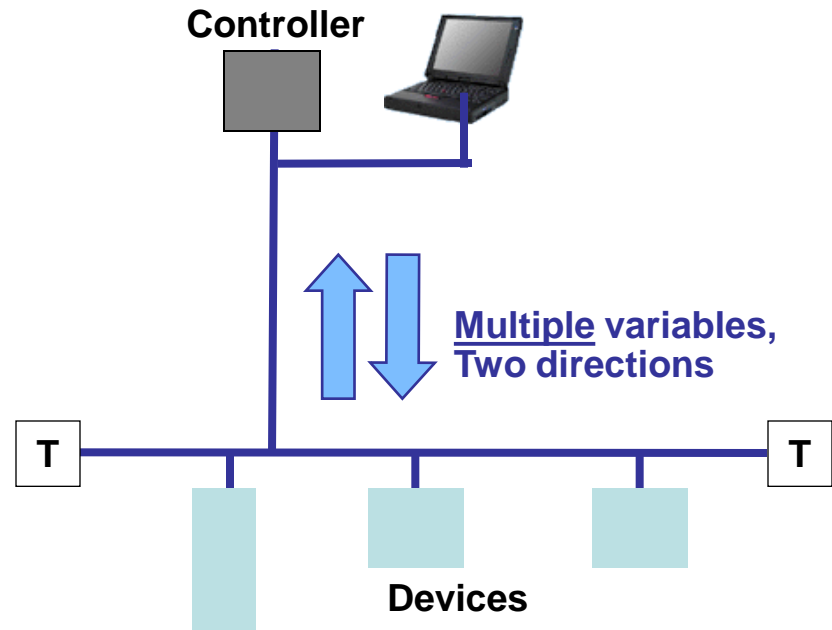

PROFIBUS

Expanded system view,
device details are „visible“



■ Example from a chemical plant:
“Level in reactor 2B gets out of spec”

- Conventional system (left) reports just undefined “Failure”.
- PROFIBUS (right) reports exact diagnosis information.

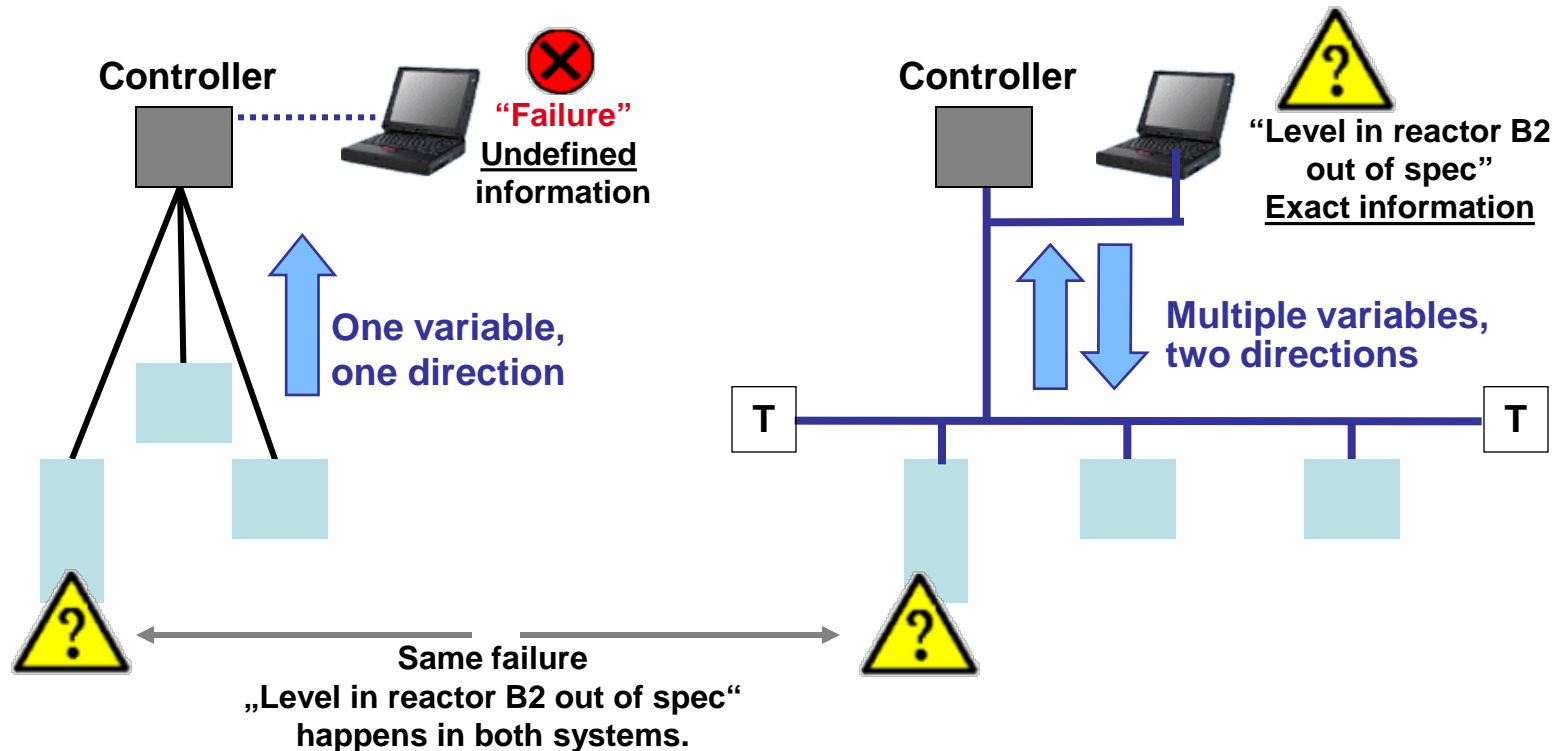

■ Before profile 3.02 was introduced

all diagnosis messages have been provided to all users.
>> Difficult to manage by the operators

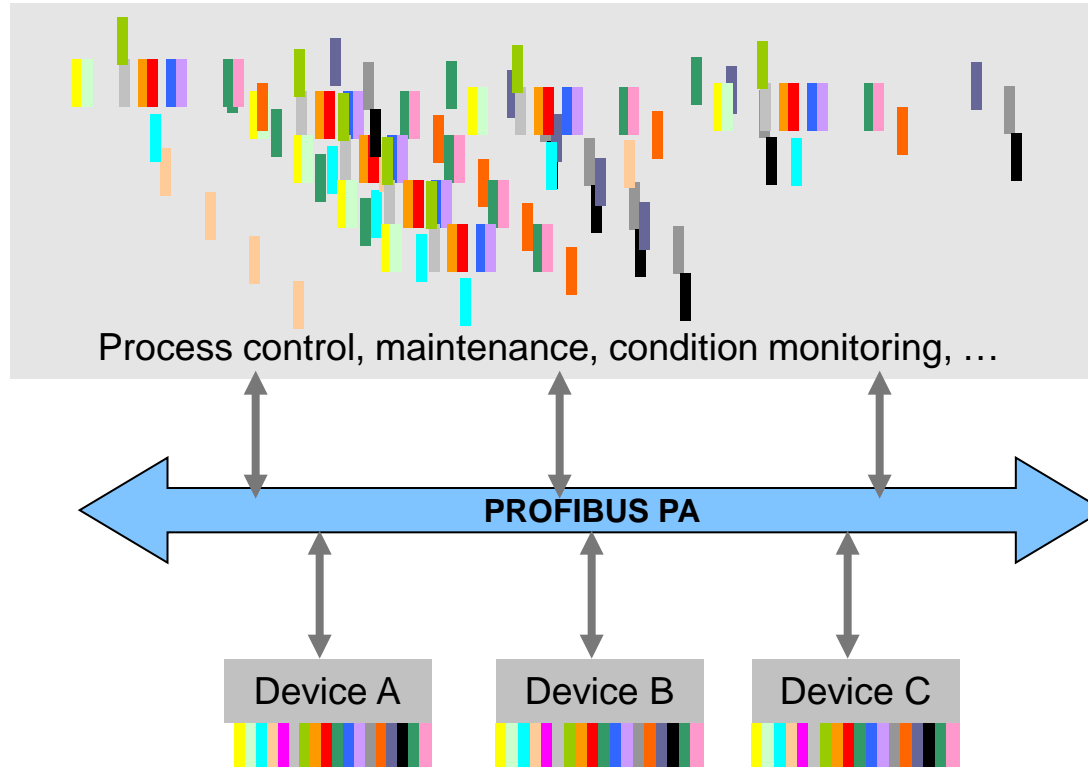

■ With Profile 3.02

- Diagnosis messages are mapped to categories already by the manufacturer, categories comply with NAMUR NE 107.
- Plant operator gets categorized information.
- Maintenance department gets full information.

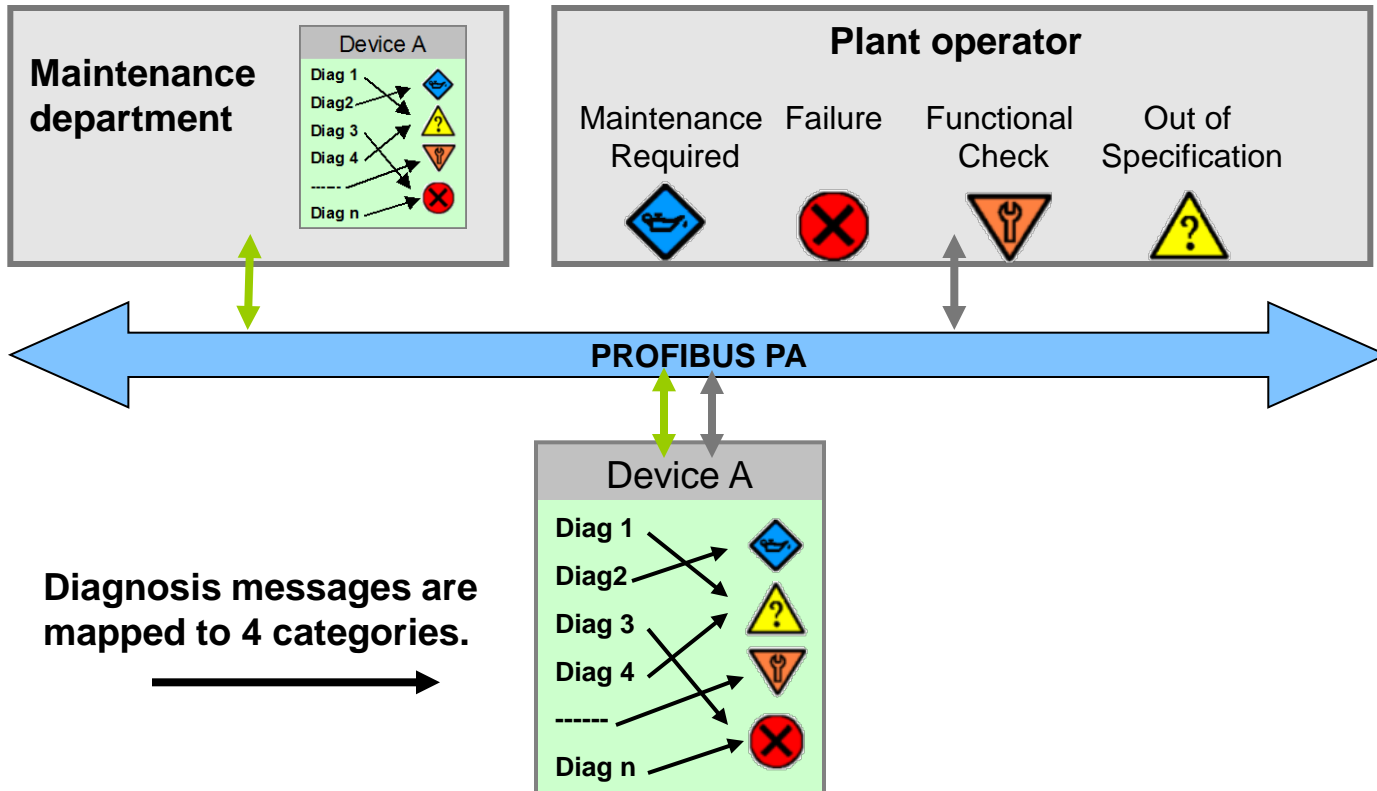

Field Device Integration

GSD
EDD
FDT
TCI
FDI



Field device integration

- PROFIBUS supports different technologies
- GSD, EDD, FDT/DTM and TCI

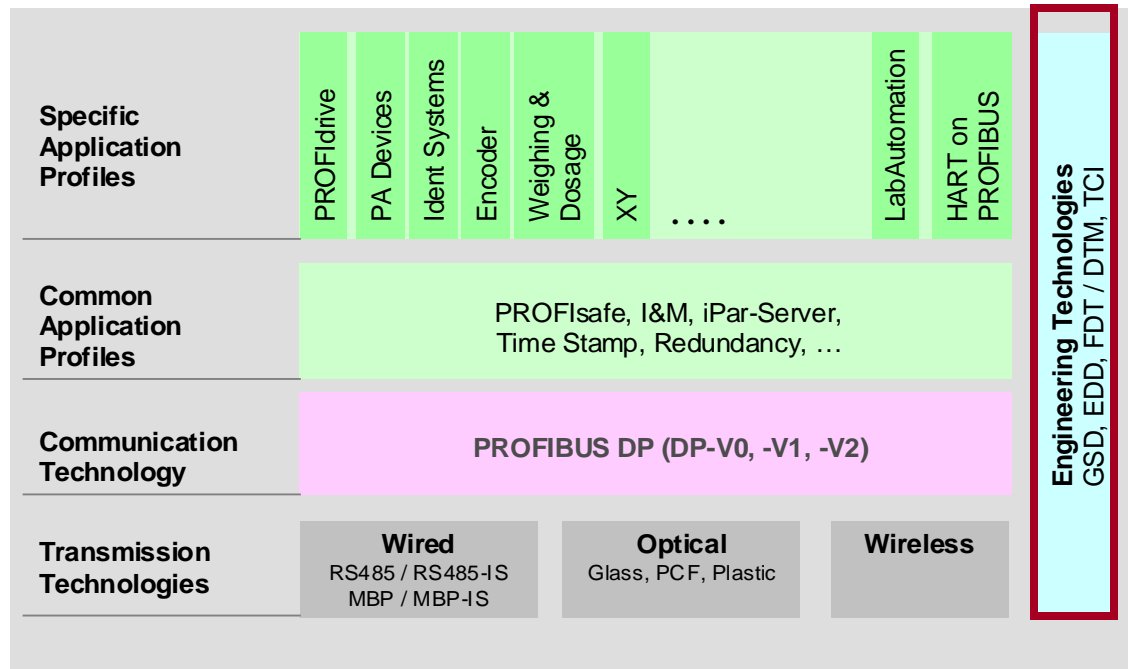

GSD (General Station Description)

- Mandatory basic textual description for any PROFIBUS device
- Used for device integration into the master and exchange of measured values and manipulated variables.

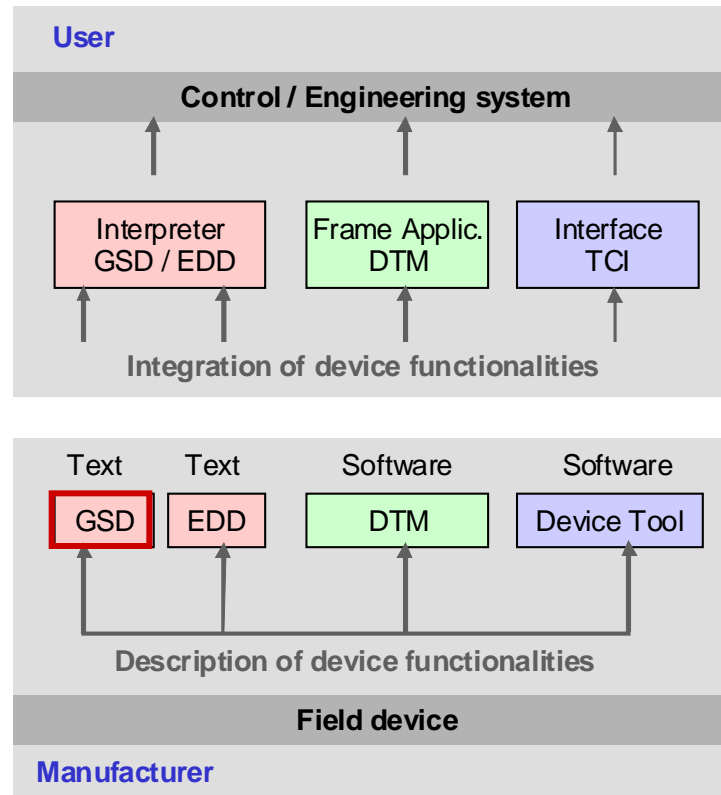

■ EDD (Electronic Device Description)

- Used in addition to GSD to textually describe application-specific functions and parameters of complex field devices.
- Allows exchange of additional information with the master for e.g. diagnosis or asset management.

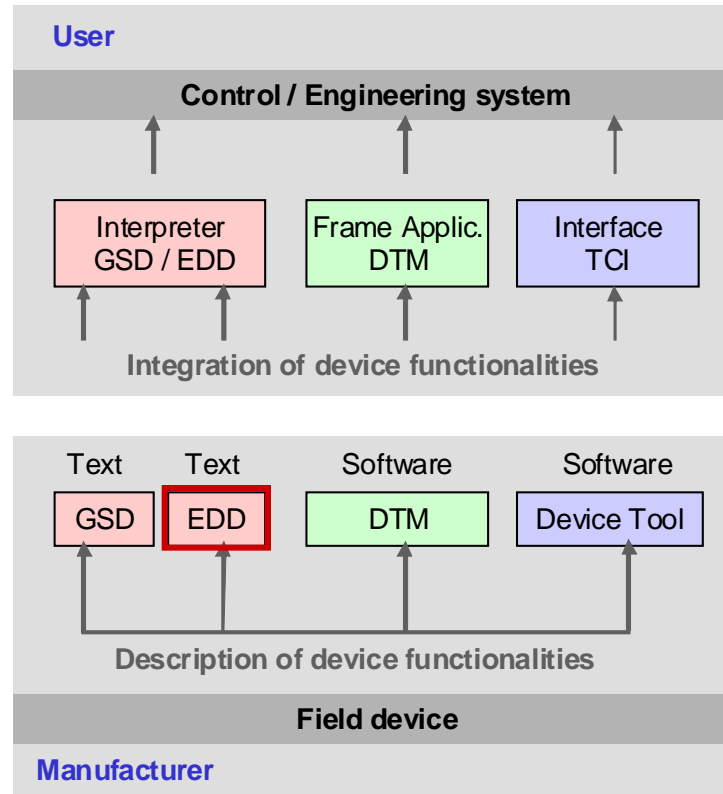

FDT/DTM

- Software-based method of device integration
- A DTM is a software component which describes a device. It communicates with the engineering system via the FDT-interface (Frame Application).

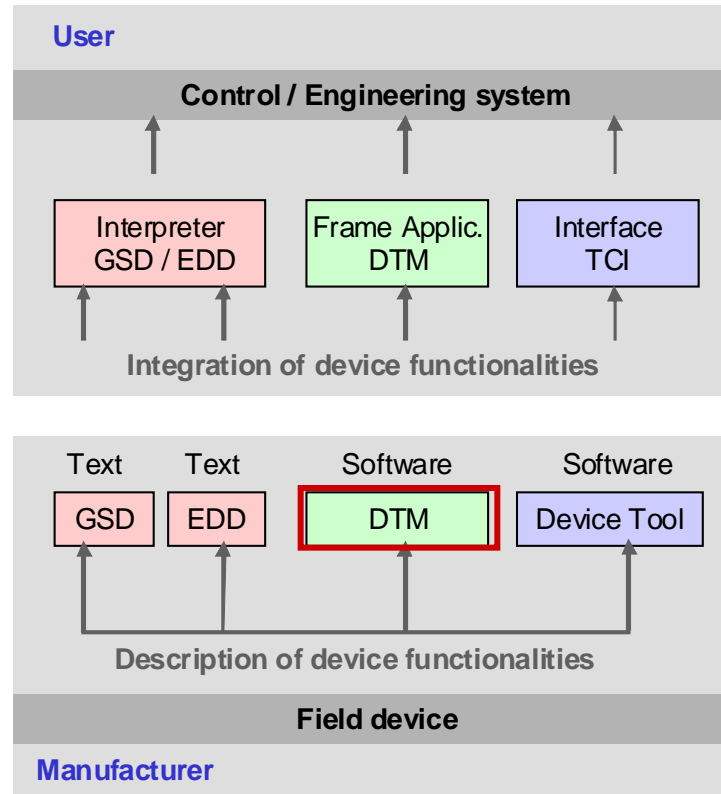

■ TCI (Tool Calling Interface)

- TCI is an open interface between the engineering tool of the overall system and the device tools of complex devices.
- TCI enables centralized parameterization and diagnostics from the engineering station during operation.

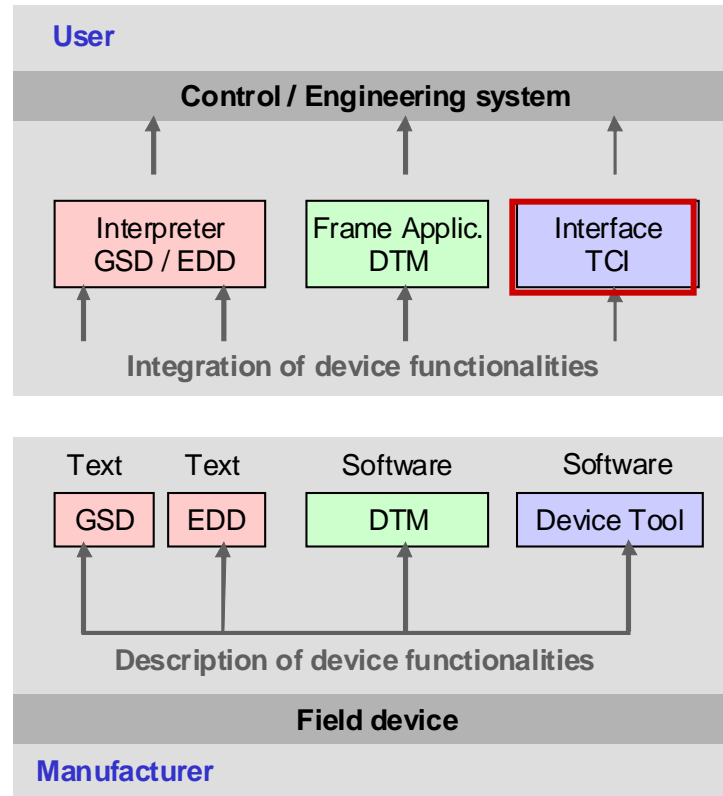

■ Field Device Integration, a new technology

- Up to date, two different integration technologies (EDD and FDT) exist. Device users and device vendors are faced with making a choice resulting typically in extra costs on both sides.
- FDI (Field Device Intergration) is a new integration technology which aims to deliver a single, unified answer to the presence of the two technologies.
- In 2011, five Automation Foundations including PROFIBUS & PROFINET International got together as “FDI Cooperation” to develop a unified solution.
- In November 2013 a specification of FDI has been published and handed over to the IEC as a Proposed International Standard.



FDI Device Package

- The core of FDI technology is the scalable FDI Device Package. It describes a field instrument or an automation component in all aspects and details

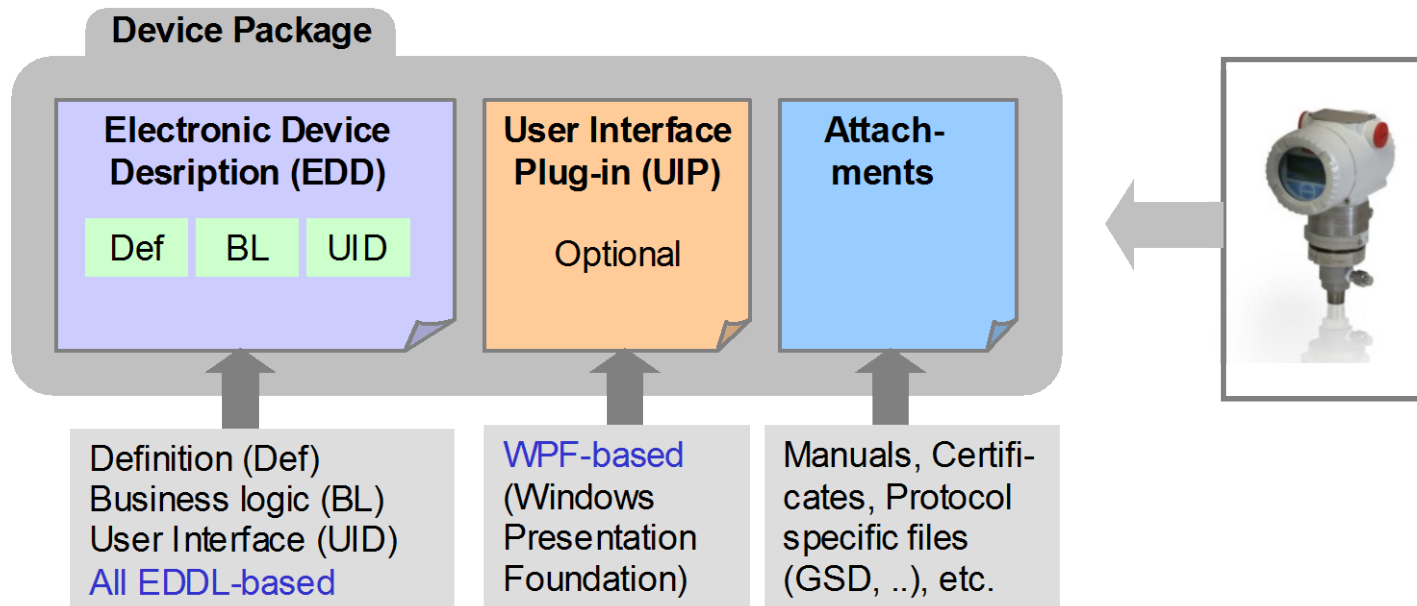

- The core of a FDI Device Package is the device specific Electronic Device Description (EDD), which uses the harmonized EDD-Language (EDDL, IEC 61804).
 - Definition (DEF): General aspects of the device (int. structure etc.)
 - Business Logic (BL): Ensures primarily data consistency
 - Mandatory User Interface Description (UID): Allows complete operation of the device

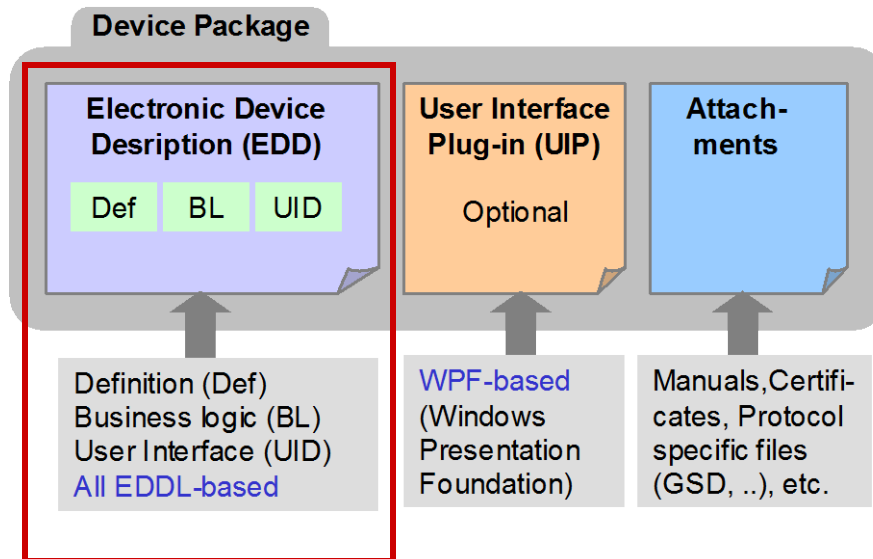

- The (optional) User Interface Plug-ins (UIP) allows freely programmable user interfaces (*Based on Windows Presentation Foundation, WPF*)
- Attachments comprize product documentation, protocol-specific files such as GSD, certificates, service manuals, etc.

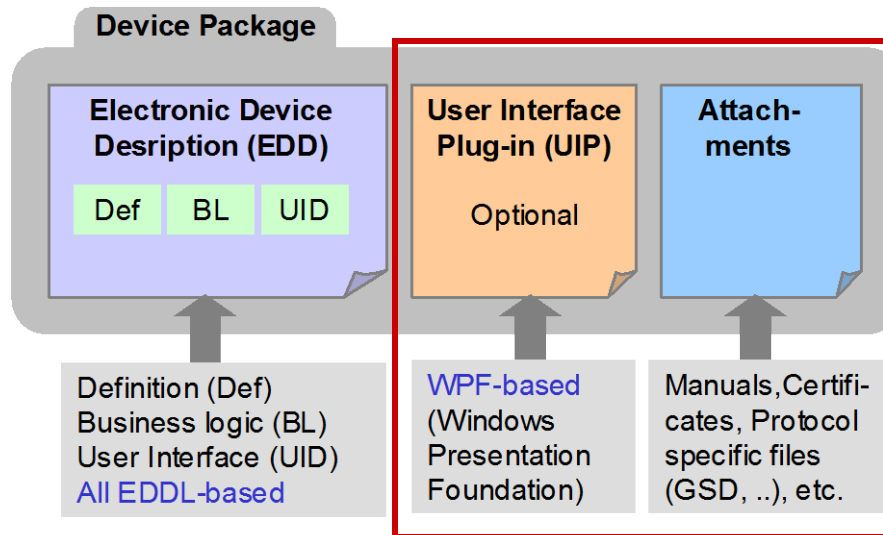

■ Processing of FDI Device Packages

- “FDI Device Packages” can be processed in two environments: in FDI hosts as well as in FDT2™ frame applications

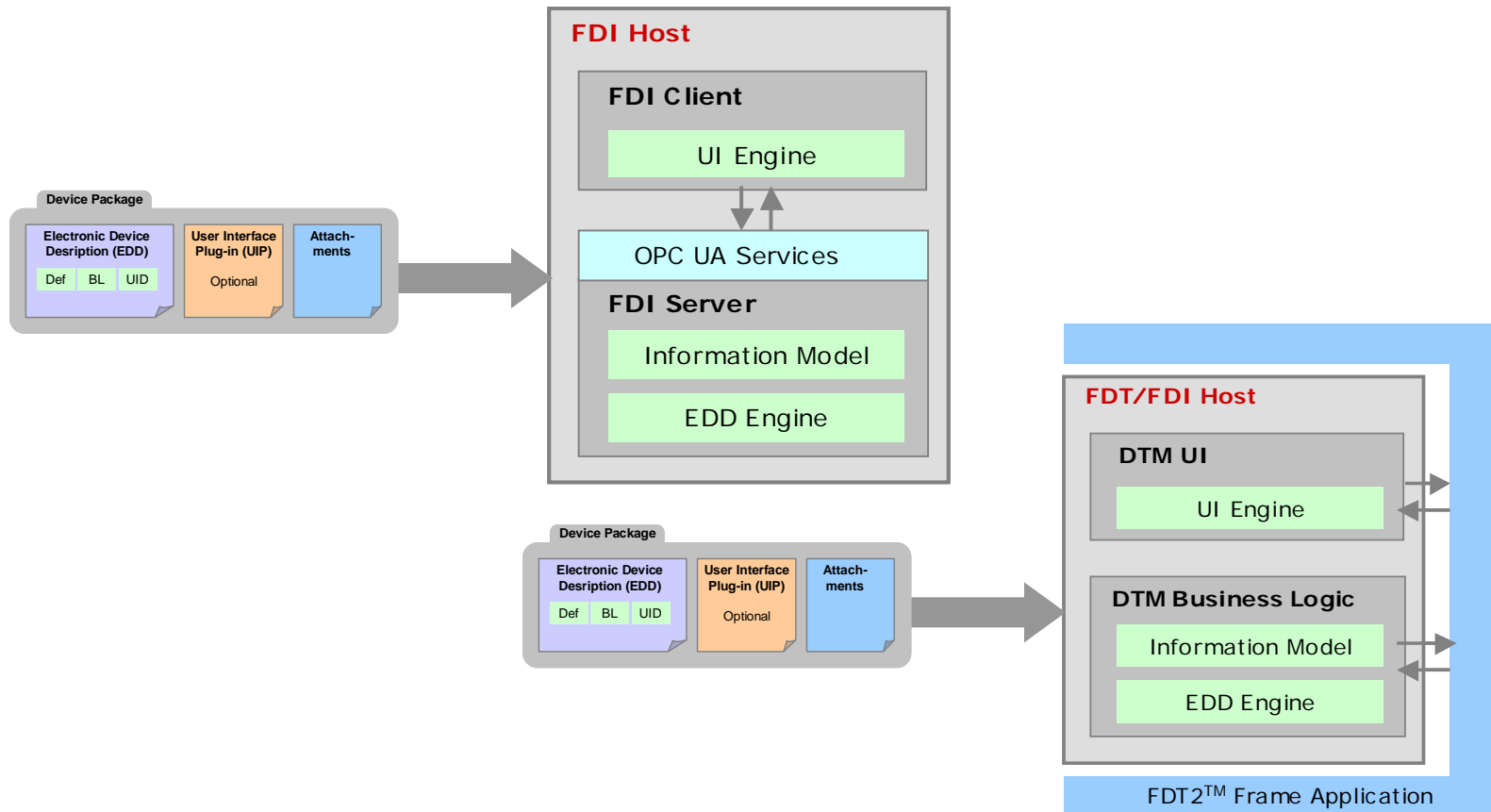

- “FDI Device Packages” are **imported** by FDI Hosts and not installed like programs. This means...
 - After importing a device package, the user can immediately start operating the device, and
 - No rebooting is needed and no interoperability problems with components and Windows version will happen.

- Other Advantages
 - Users still have the choice of working with either a FDI host or an FDT host environment.
 - Device suppliers have to develop just one FDI Device Package for a certain device instead of separate DDs and DTMs.



- FDI Hosts
- FDI hosts are a powerful interface to field devices
- FDI Host could be
 - Device management software as part of a Process Control System
 - A Plant Asset Management System
 - A device configuration tool on a laptop or handheld field communicator



- Common Host Components
- To ensure same behavior of FDI Device Packages in various systems, uniform and multi-protocol host components has been developed:
- **UI Engine** ensures that user interface elements (UID and UIP) are executed in the same way in different host systems.
- **EDD Engine** supports the entire scope of EDDL versions in accordance with IEC 61804 in a multiprotocol manner including backward compatibility.

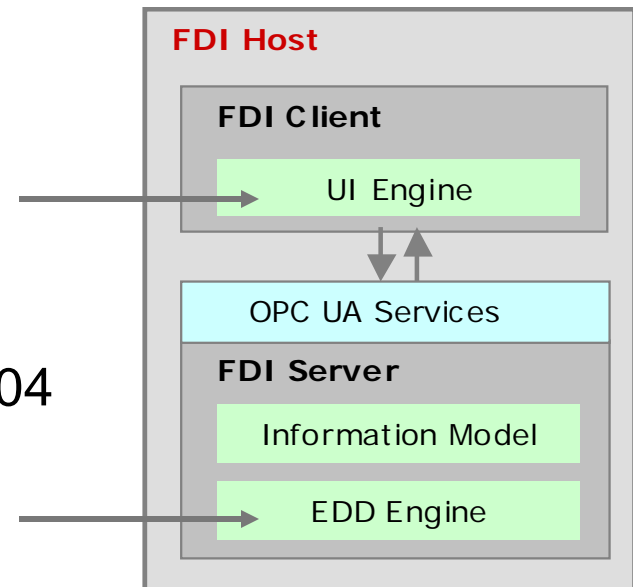

■ FDI – Scalable architecture (1)

- The FDI standard allows the implementation of different software architectures for a host starting from a tool for a single user up to a distributed multi-user application with client/server architecture
- FDI clients are used by operators to work with automation instruments
- The FDI server manages device packages, involves communication to connected devices using standard protocols, maps the communication topology to the automation system etc.

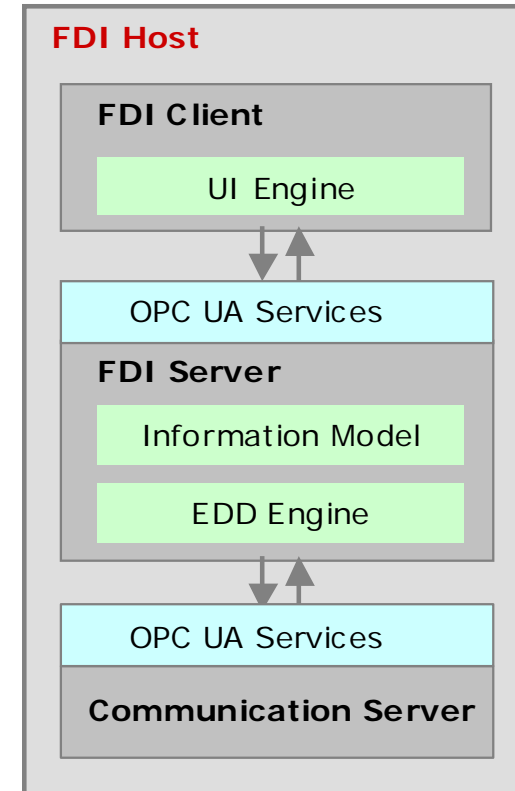

■ FDI – Scalable architecture

- Standard protocols like HART, PROFIBUS, PROFINET, Foundation Fieldbus are supported by the FDI server. Other protocols are supported by the FDI communication server(s)
- OPC-UA is used as interface in FDI hosts. The OPC UA services allow secure access to the devices and allows easy access from and to other applications
- The information model represents the device instances and the entire communication infrastructure.

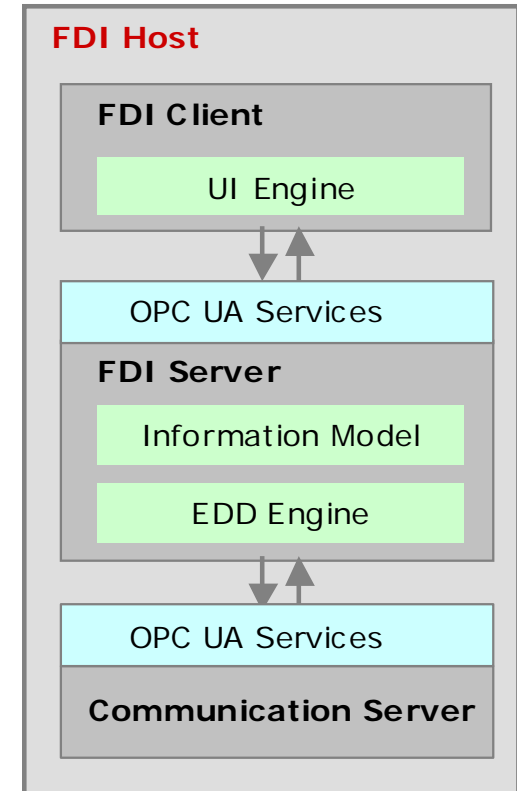

■ FDI – Scalable architecture

- The information model represents the device instances and the entire communication infrastructure.

If an FDI client wants to work with a device, it accesses the information model and, for example, loads the user interface of the device in order to display it on the client side

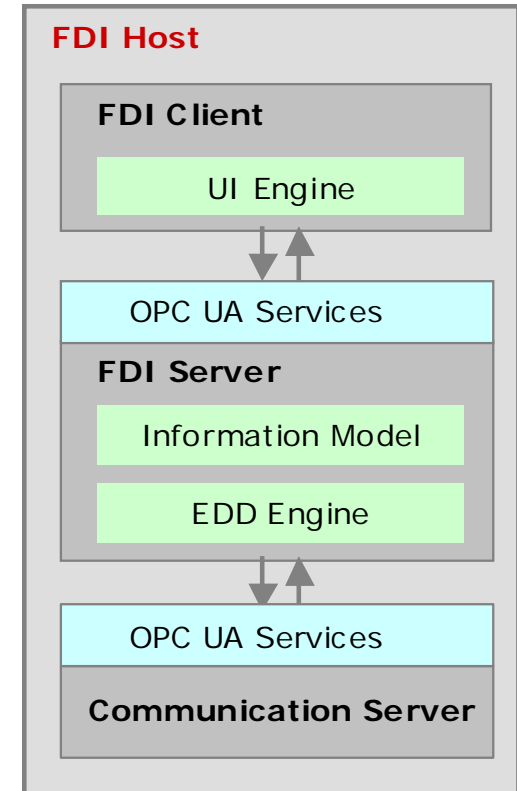

PROFIBUS Components and Topology



■ Repeaters

- Repeaters are devices that repeat an electrical signal thereby returning it to its full strength but introducing a delay in the signal.
- Repeaters extend the total length of a network and the number of devices on the network.
- Repeaters are mainly used in DP-networks with their daisy chain topology to allow more devices connected to the network.
- In PA-networks, a coupler with a new PA-segment can be added in case of an overloaded segment and to add more devices.



■ Couplers and Links

- PROFIBUS PA segments are attached to the PROFIBUS DP backbone through some sort of coupler or link.
- A number of companies supply such kind of equipment with different technical features and designations:
 - „PROFIBUS DP/PA Segment coupler“
 - „PROFIBUS DP/PA Link“
 - „PROFIBUS DP/PA Linking device“

■ Junction boxes (for PROFIBUS PA)

[Link to „Topologies“](#)

- Junction boxes (also fieldbus coupler, field barrier, multibarrier, ...) are used to connect spur lines to the trunk and offer numerous special features that vary between models and manufacturers. [For details see chapter „How to install PROFIBUS?“](#).



PROFIBUS in hazardous environments

MBP-IS
FISCO
High-
Power-
Trunk



- In hazardous environments, fieldbus systems must comply with two IEC standards:
 - IEC 60079: Explosive atmospheres
 - IEC 61158-2: Fieldbus/Physical layer specification

- Hazardous zones and PROFIBUS solution
 - Zone 0, 1 and 2 define areas of a plant, where explosive substances may exist in the air and an electrical spark could trigger an explosion
 - The respective PROFIBUS solution limits the energy going to the bus and the devices to eliminate the danger of generating a spark

- The „Intrinsically Safe (IS)“ version of the MBP physical layer (MBP-IS) complies with this approach.

See also chapter [“transmission technology“](#) .



■ Data of MBP and MBP-IS physical layers

	MBP PROFIBUS PA	MBP- IS PROFIBUS PA
Baud rate	31.25 kBit/sec	31.25 kBit/sec
Voltage	24 ... 30 V	13,2 V
Current	1000 mA	110 mA
Devices/segment (max.)	32	
Devices/segment (typic.)	14 ... 20	4 ... 6
Cable length max.	1900 m	1000 m
Spur line length max.	120 m	60 m

Note:

RS485 is also available in an IS-version, which runs at lower power levels with a special coupler and a special wiring.

This is a cost effective solution for remote I/O in IS environment.



■ **Fieldbus Intrinsically Safe Concept (FISCO)**

- The FISCO (Fieldbus Intrinsically Safe Concept) provides easy and fast design of PROFIBUS PA installations in hazardous areas.
- FISCO enables to get IS approval without individual calculations.
- FISCO requirements:
 - Only one power source permitted.
 - All other components are drains.
 - Maximum overall cable length 1000 m
 - Maximum spur line length 60 m
 - Power supply, coupler and field devices must be FISCO certified.



■ From Intrinsic Safety to the High-Power-Trunk

- Intrinsic safety (I.S.) is the method of choice for instrument connections in hazardous areas.
- I.S. does not satisfy completely the needs regarding to cable length and number of devices compared to applications outside of hazardous areas.
- The High-Power Trunk Concept solves this limitation and makes PROFIBUS PA best suited for use in hazardous areas.



High-Power-Trunk to supply Zone 1

- The trunk is installed with increased protection in zone 1 to allow increased supply current for more field devices.
- The field devices are connected using Ex i ignition protection.

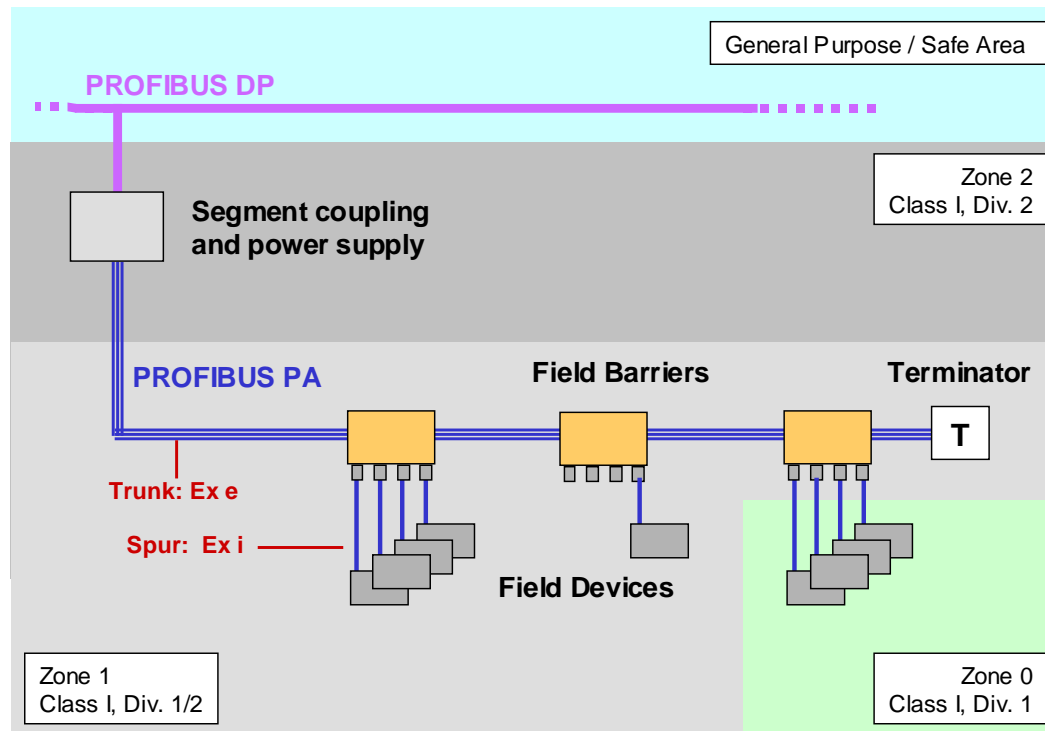

High-Power-Trunk to supply zone 2

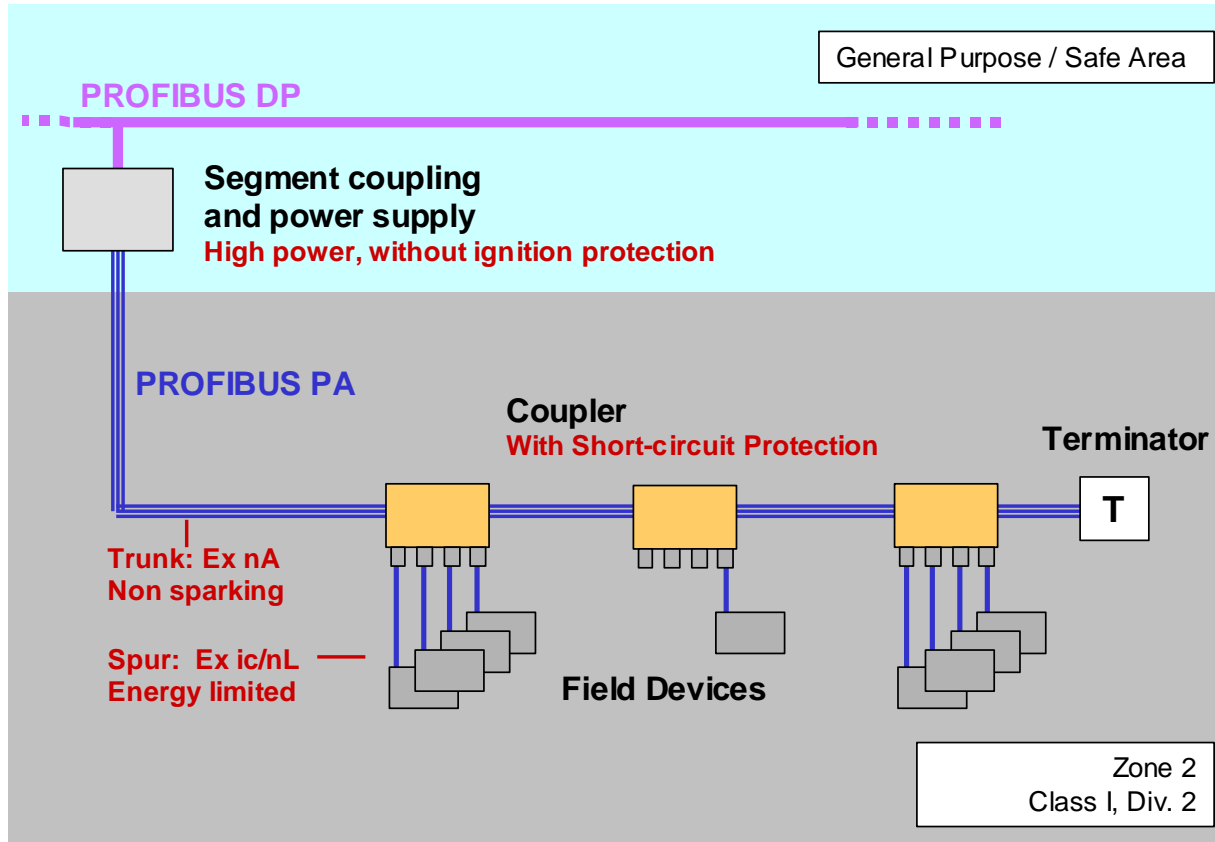

PROFIBUS in Safety Applications (PROFIsafe)

PROFIsafe
enables all
kinds of
Safety
Applications



- Objective of “Safety” is to avoid accidents and damages in case of failures and to ensure maximum safety for ...

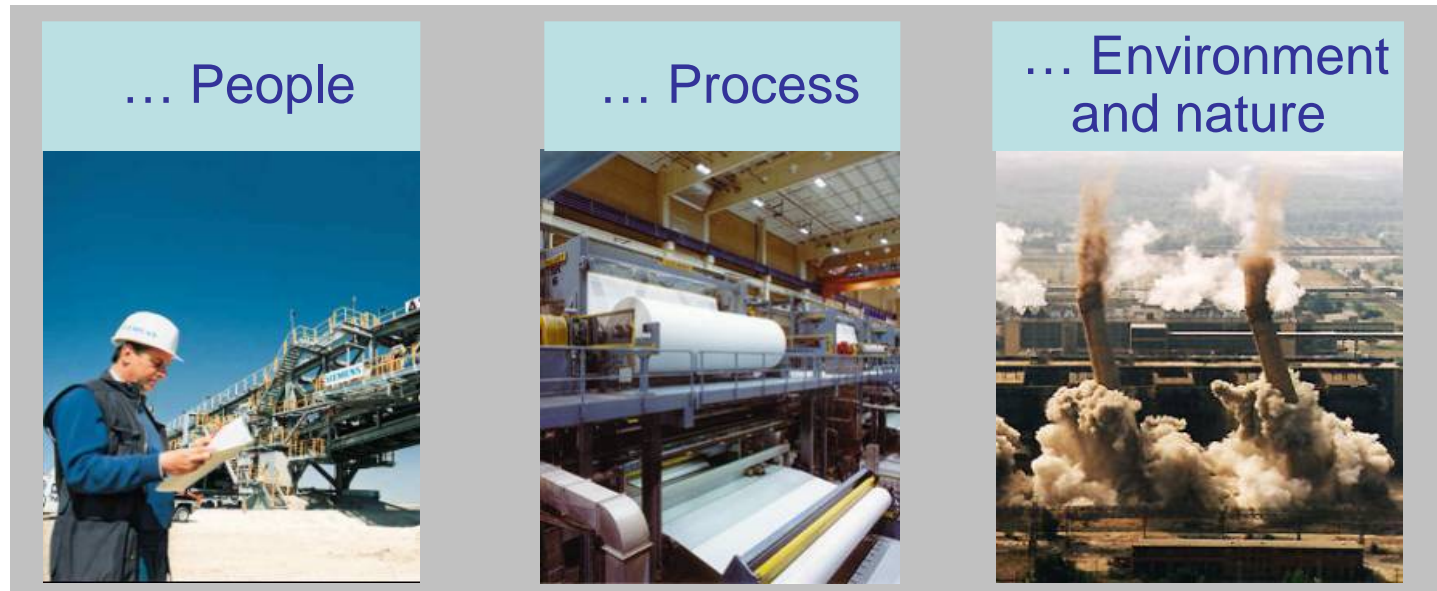

- Safety applications are essential in all sectors of automation.



- Objective: Reduce the risk to an acceptable level.
- Solution: Install risk reduction measures including safety systems.

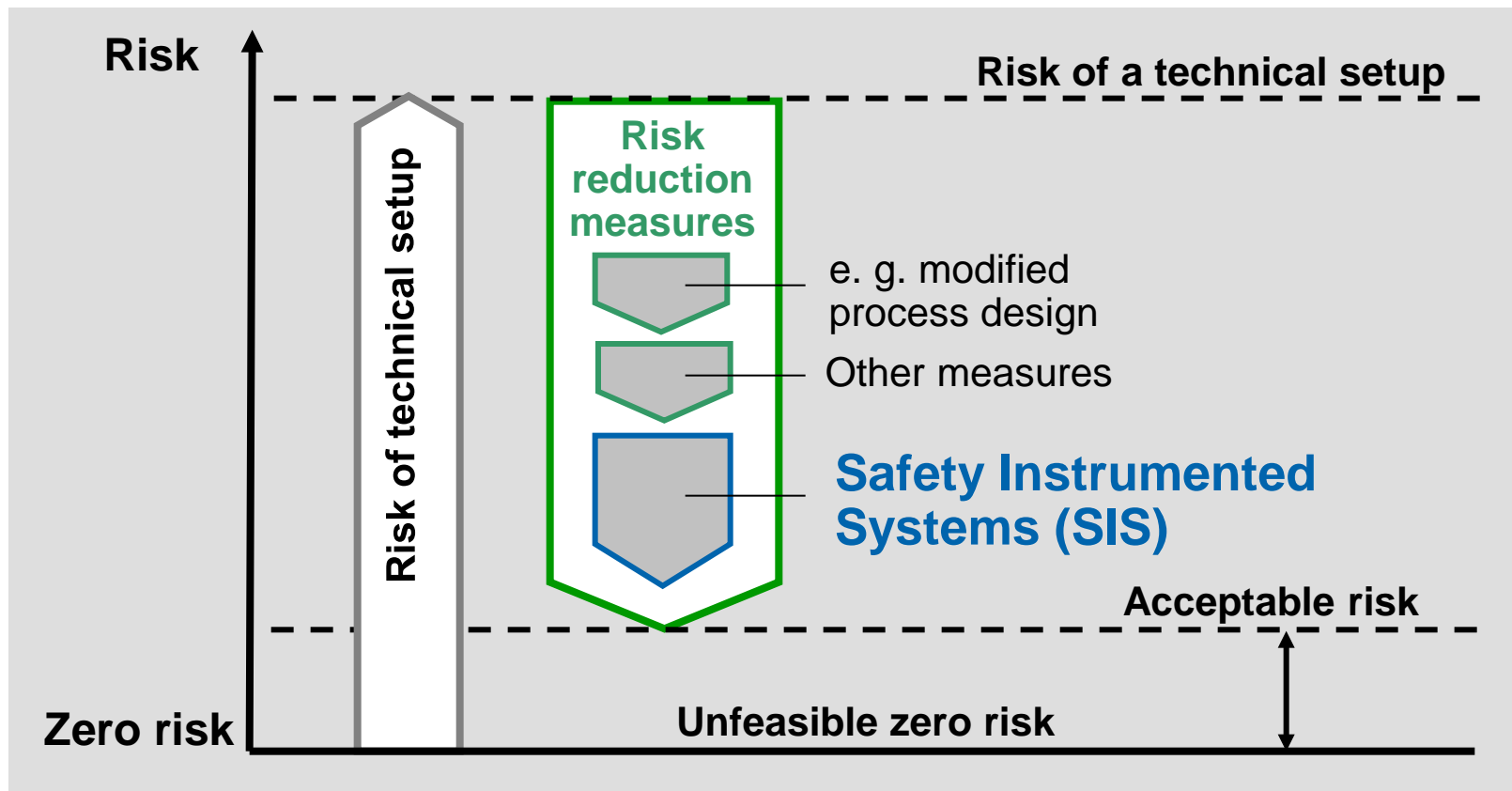

■ SIL and Risk Reduction

- **SIL:** A performance criteria of a Safety Instrumented System (SIS) which describes, among other things, the Probability of Failure on Demand (PFD).
SIL covers four levels SIL 1 to SIL 4.
- **PFD:** A value that indicates the probability of a system failing to respond to an actual demand.
PFD is also referred to as “safety unavailability”.

Safety Integrity Level (SIL)	Probability of failure on demand (PFD) per year	Risk Reduction Factor (1 / PFD)
SIL 1	$\geq 10^{-2}$ to $< 10^{-1}$	100 to 10
SIL 2	$\geq 10^{-3}$ to $< 10^{-2}$	1000 to 100
SIL 3	$\geq 10^{-4}$ to $< 10^{-3}$	10 000 to 1000
SIL 4	$\geq 10^{-5}$ to $< 10^{-4}$	100 000 to 10 000



■ Safety Instrumented System (SIS)

A combination of sensors, logic modules (e.g. controls) and actuators which detects abnormal operating conditions and returns the plant automatically to a safe state again.

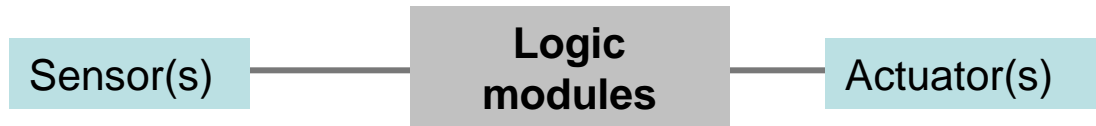

■ Safety technology

progressed from conventional relay controls to safety control systems.

■ Safety communication

uses using standard and proprietary bus systems.

■ With PROFIsafe, PROFIBUS has a leading position:

- PROFIsafe is an additional communication layer above layer 7. It completely covers factory and process automation applications. It covers the entire transmission path from sensor/IO to the controller.
- PROFIsafe is standardized in IEC 61784-3-3 and complies with SIL 3 according to IEC 61508.
- With PROFIsafe, safety communication is combined with the benefits of standard communication, both using the same bus or cable.



Standard and safety communication on the same bus

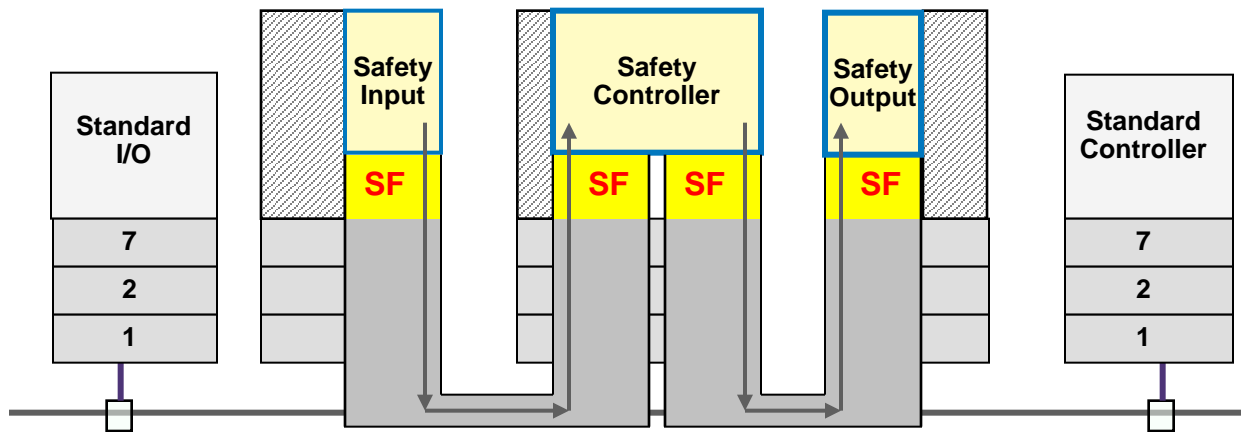

Black Channel:

Not safety-related components such as ASICs, links, cables etc.



PROFIsafe (Safety Function, Safety Layer)

Part of the safety-related communication system, located above layer 7
Safety Layers checks addressing, signature, fault tolerance time etc.



Safety-related components (I/Os, controller, control systems)

These are not part of PROFIsafe!



Not safety-related functions, e.g. diagnosis



PROFINET in Process Automation

Overview



- PROFINET (PN) is Industrial Ethernet for Factory and Process Automation
- PROFINET is established in Factory Automation (FA) and feels increasing demand in Process Automation (PA)
- PA shows different characteristics compared to FA, e.g.
 - Signal cycle times from < 100 ms (RT) to < 1 ms (IRT)
 - Higher reliability and availability required 24 hours / 365 days operation
 - Plant life cycle time 20 years and more
 - Actors and sensors much more complex
 - Plants with up to 100.000 I/O signals



- Four major extensions to PROFINET have been developed to meet Process Automation's requirements:
 - **Investment protection (Integration of existing fieldbuses)**
 - **Configuration in Run**
 - **Time Synchronization and time Stamping**
 - **Scalable redundancy**



■ Investment protection

- Communication systems used in PA (PROFIBUS PA, HART and Foundation Fieldbus) are integrated into a PROFINET network by means of the “Proxy technology”.
- The “Proxy” assumes responsibility for implementing the physics and protocol and ensures the exchange of all data and alarms with the field devices.

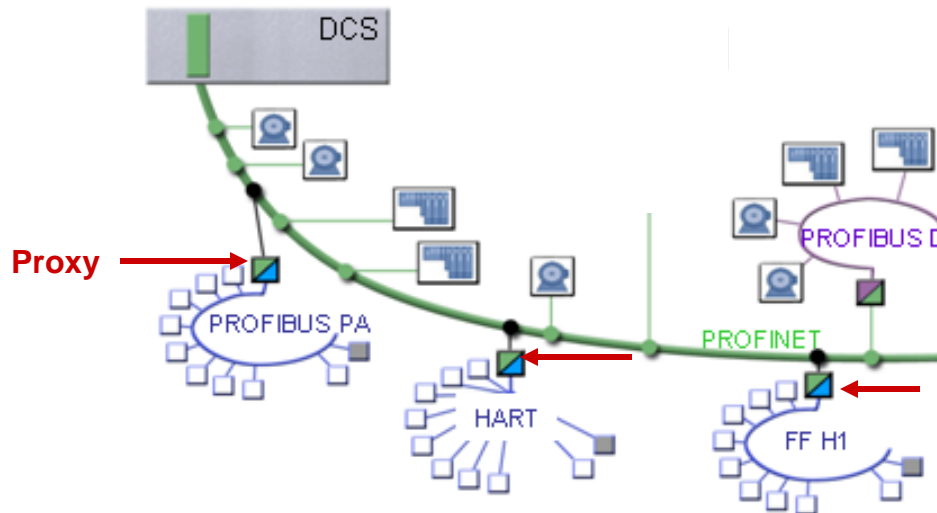

■ Configuration in Run

- Plant availability is of top priority in process automation and no interruption the of production process is accepted during exchanging field devices or changing parameters etc.
- Thanks to auto-sense and topology detection features, devices are identified automatically by the DCS to allow configuration scenarios carried out without any interruption.



■ Time synchronization and time stamping

- In process automation, time-correct tracking of individual signals is important especially in case of malfunctions.
- A time stamp for digital and analogue values and alarms that is accurate to the millisecond is set by means of a central master clock.

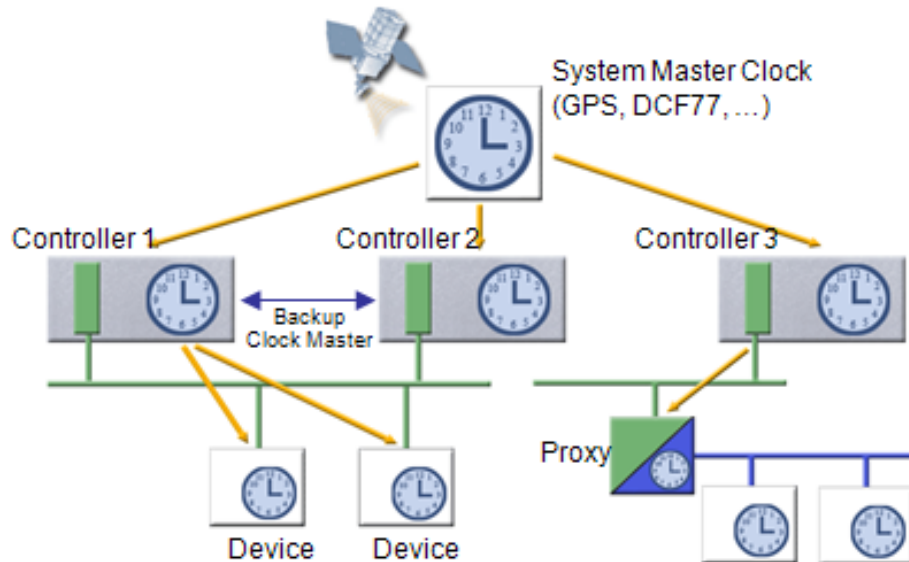

■ Scalable redundancy

- To avoid failures caused by wire breaks or short circuits, different redundancy (scalable redundancy) are available: Controller redundancy, network redundancy, device redundancy or device interface redundancy.
- The basis is the automatic switchover of communication paths to intact paths in the event of a fault.

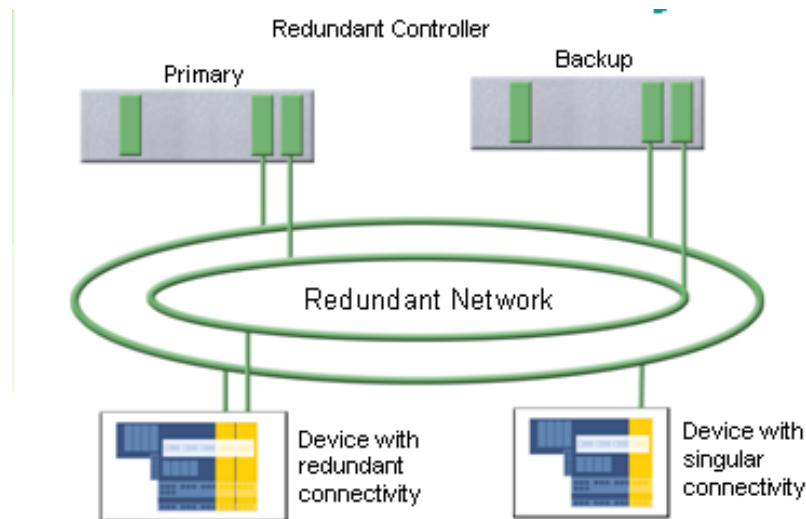

How to design PROFIBUS?

PROFIBUS
provides
clear
design and
topology
concepts



■ PROFIBUS uses two physical layers: RS-485 and MBP

- In “PROFIBUS DP”, the “DP Protocol” runs on RS-485.
- In “PROFIBUS PA”, the “DP Protocol” runs on MBP*).

	RS - 485 PROFIBUS DP	MBP PROFIBUS PA	MBP- IS PROFIBUS PA
Baud rate	9.6 ... 12.000 kBit/s	31.25 kBit/sec	31.25 kBit/sec
Devices/segment (max.)	32	32	32
Devices/segment (typic.)		14 ... 20	4 ... 6
Cable length max.	1200	1900 m	1000 m
Spur line length max.		120 m	60 m

*) **MBP**: Manchester Coded **B**us **P**owered



■ PROFIBUS DP and PA feature different network layouts

- PROFIBUS DP running on RS-485 allows only daisy chained nodes in the network layout and no spur lines.
- PROFIBUS PA running on MBP allows much more flexibility in network layout including a variety of topologies such as trunk, star, or tree.
- Both must be terminated at the extreme ends; termination characteristics are different for DP and PA networks.

*) **MBP**: **M**anchester Coded **B**us **P**owered



■ PROFIBUS DP (RS-485)

- 32 devices max. (incl. controller) on one segment.
- Devices must be daisy chained; no spur lines.
- Segment must be terminated (T).
- Baud rate depends on segment length.
- Repeater are possible, 9 max. per segment.
- Use of “recommended grounding methods”.

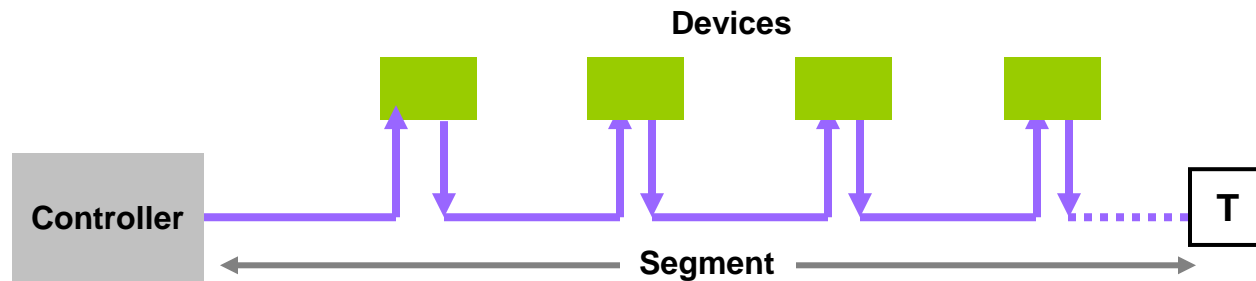

■ PROFIBUS PA - Trunk topology

- One main cable (trunk) and spur lines
- Maximum length of spurs depends on number of spurs
- T-connectors with or without short-circuit protection
- With optional overvoltage protection
- Convenient and easy solution

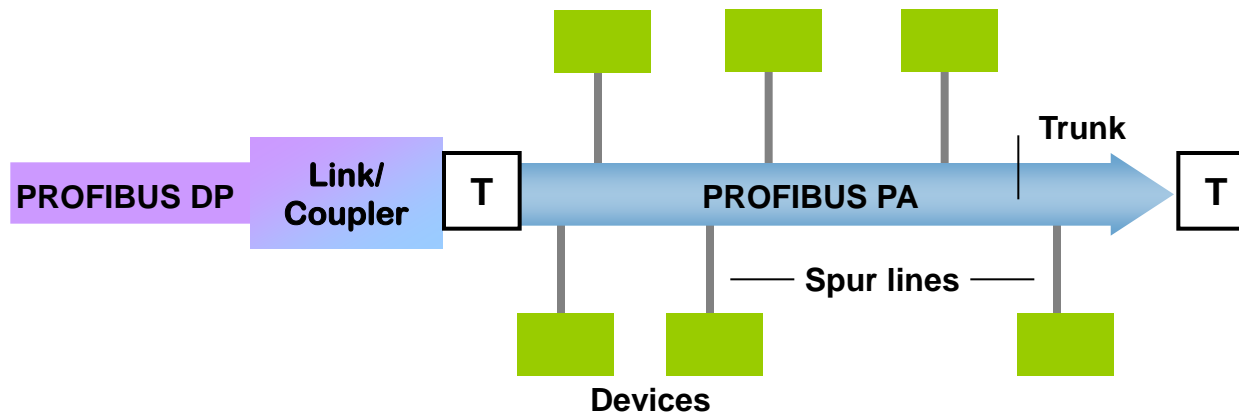

■ PROFIBUS PA - Star topology

- Junction Box with or without short-circuit protection
- All spur lines come from the junction box:
- Convenient and easy solution

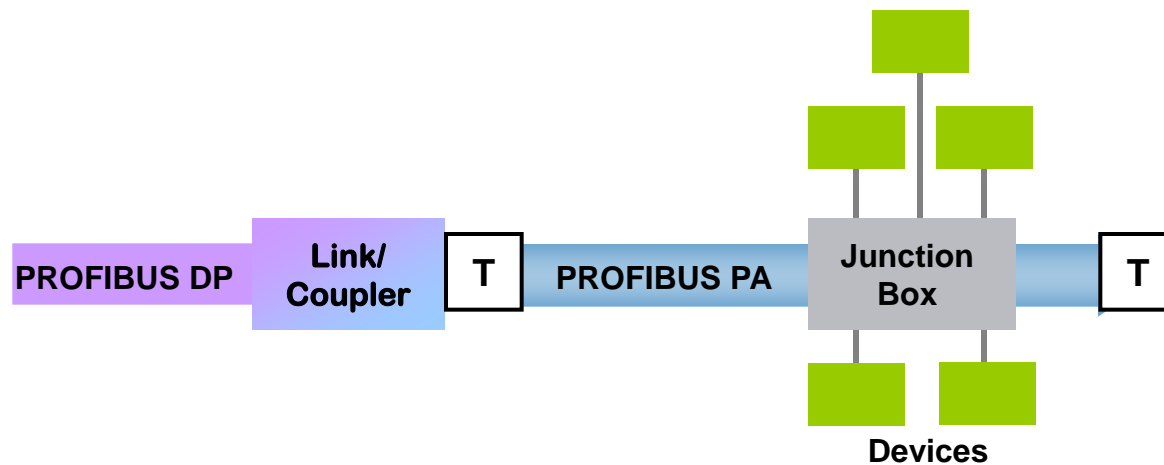

PROFIBUS PA - Trunk-and-spur topology

- Short-circuit protection at the spur lines
- Clearly arranged and easy to document

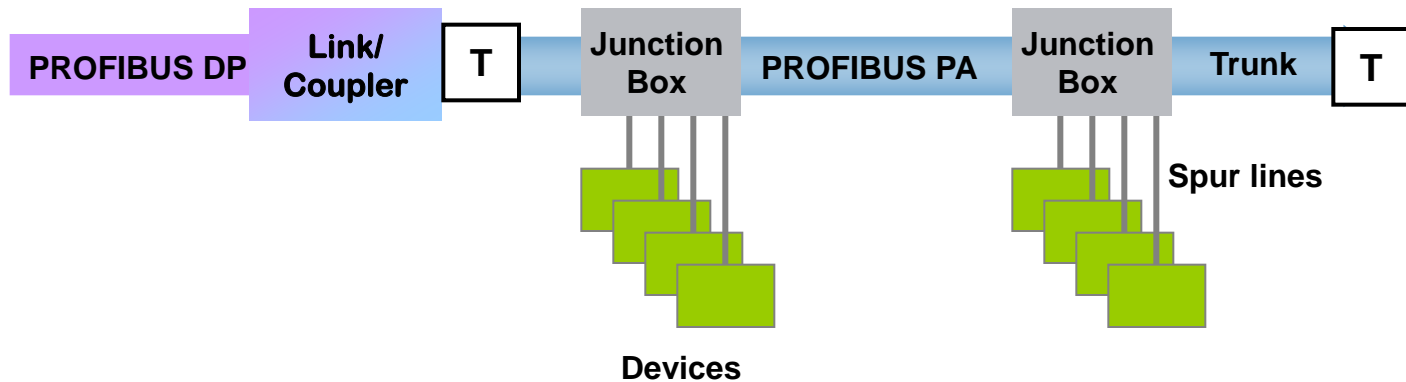

PROFIBUS PA - Ring topology

- Two redundant links/couplers
- High availability of the trunk
- Short-circuit protection at the spur

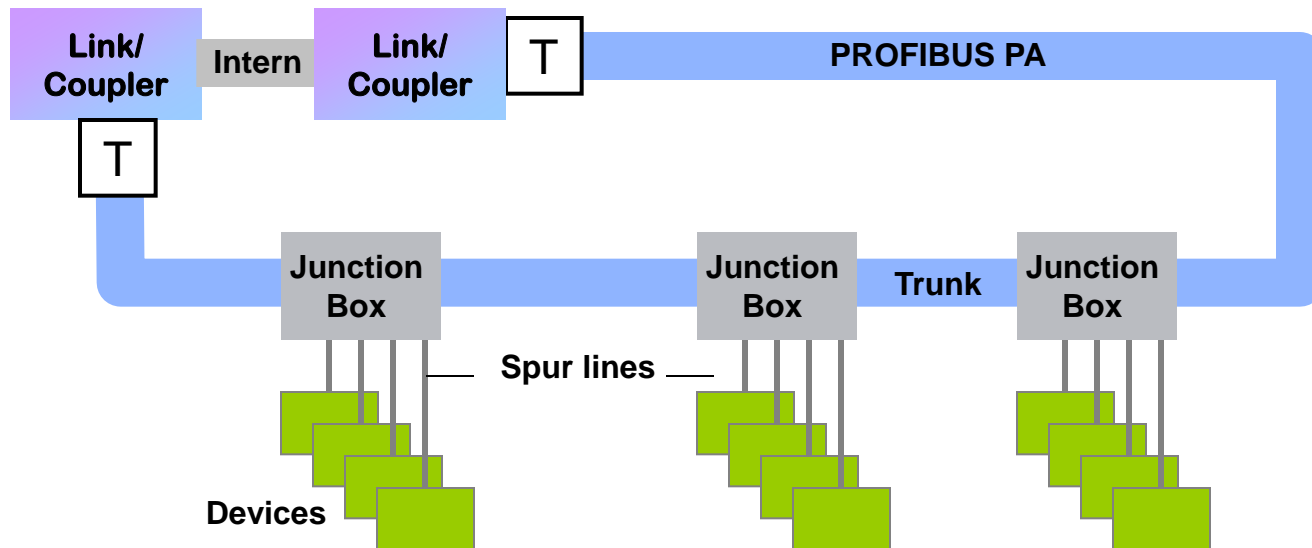

How to install PROFIBUS?

“Trunk and Spur”

The most
common
installation
concept



■ “Trunk and Spur“ is the most common installation concept.

- Very clearly arranged and easily to document
- Short-circuit protection at the spur
- Junction boxes are easy accessible.

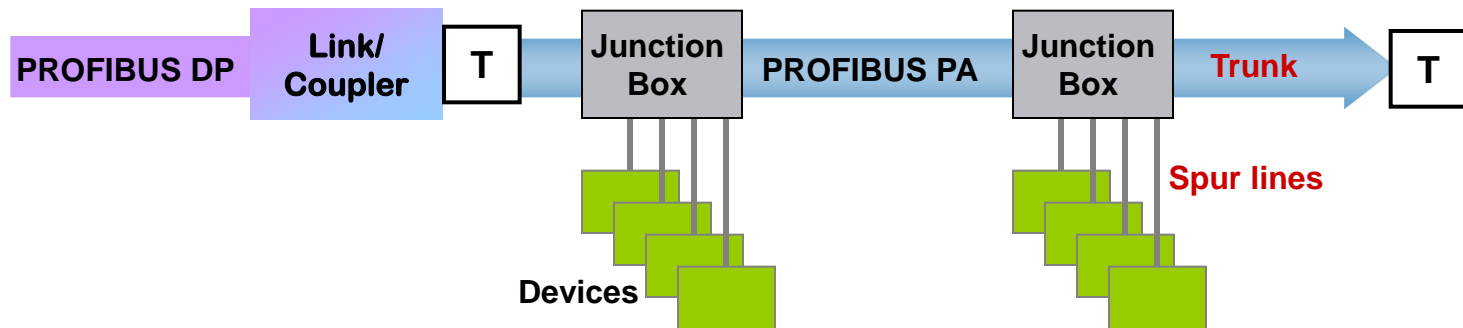

Junction boxes connect spur lines to the trunk.

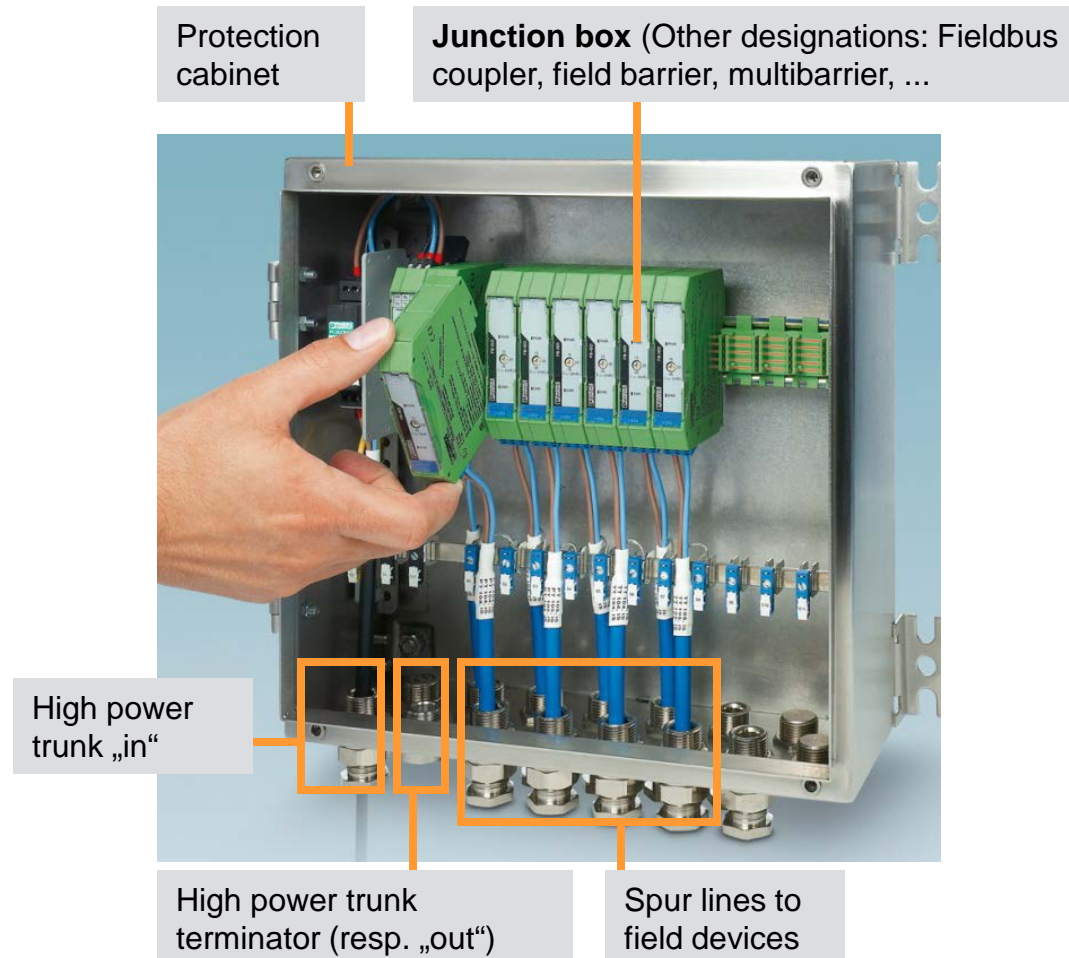

■ Fieldbus Junction Boxes

- Installed on an easy accessible location of the plant
 - Mounted in a cabinet to protect against humidity and dust
 - Coupled to the trunk which either terminates or continues to the next junction box
 - Spurs to the field devices are applied in the box
 - Electronic provides functional protection (e.g. short-cut at the spur) and explosion protection (e.g. intrinsically safe)
- Junction Boxes are available from various vendors in different design.

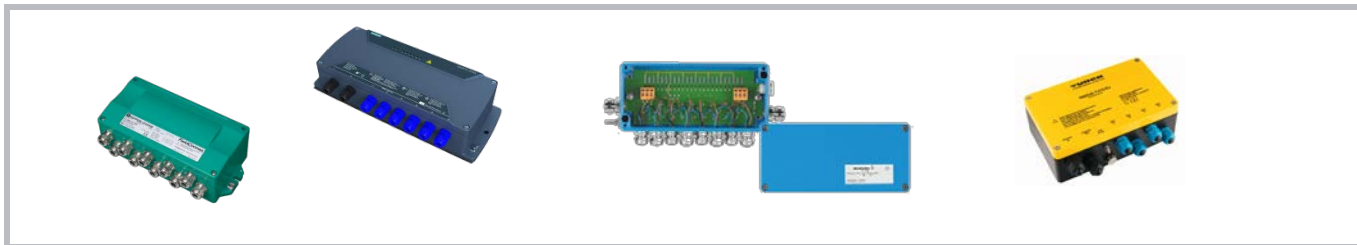

■ Shielding and Grounding

■ The recommended grounding practices:

- Connect all cable shields to ground.
- Use a grounding cable to go from cabinet to cabinet in the same segment.

■ Types of grounding:

- Direct grounding (at any connecting point)
- Capacitive grounding



Direct Grounding

- Requires potential equalisation between Ex- und non-ex areas.

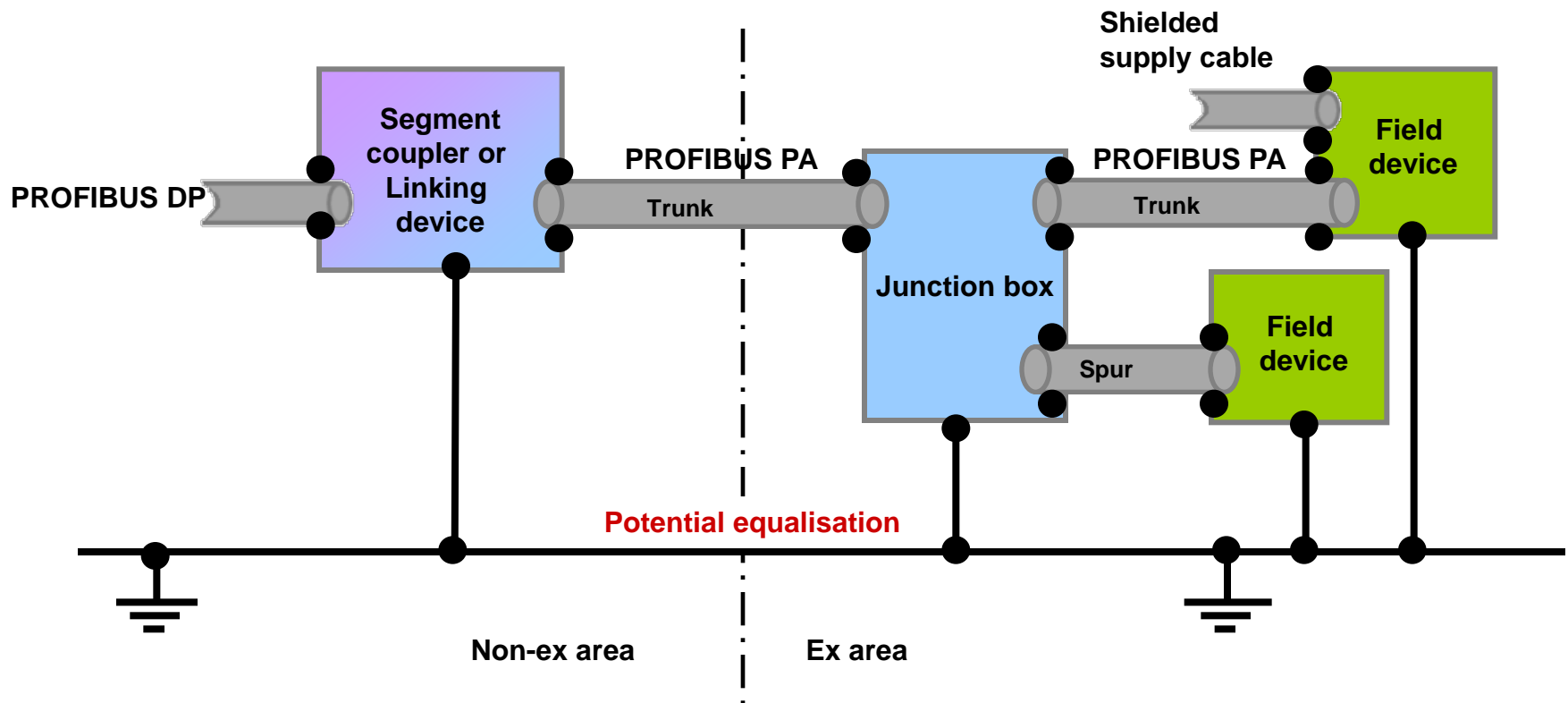

■ Capacitive Grounding

■ To be used as soon as potential equalisation is not secured.

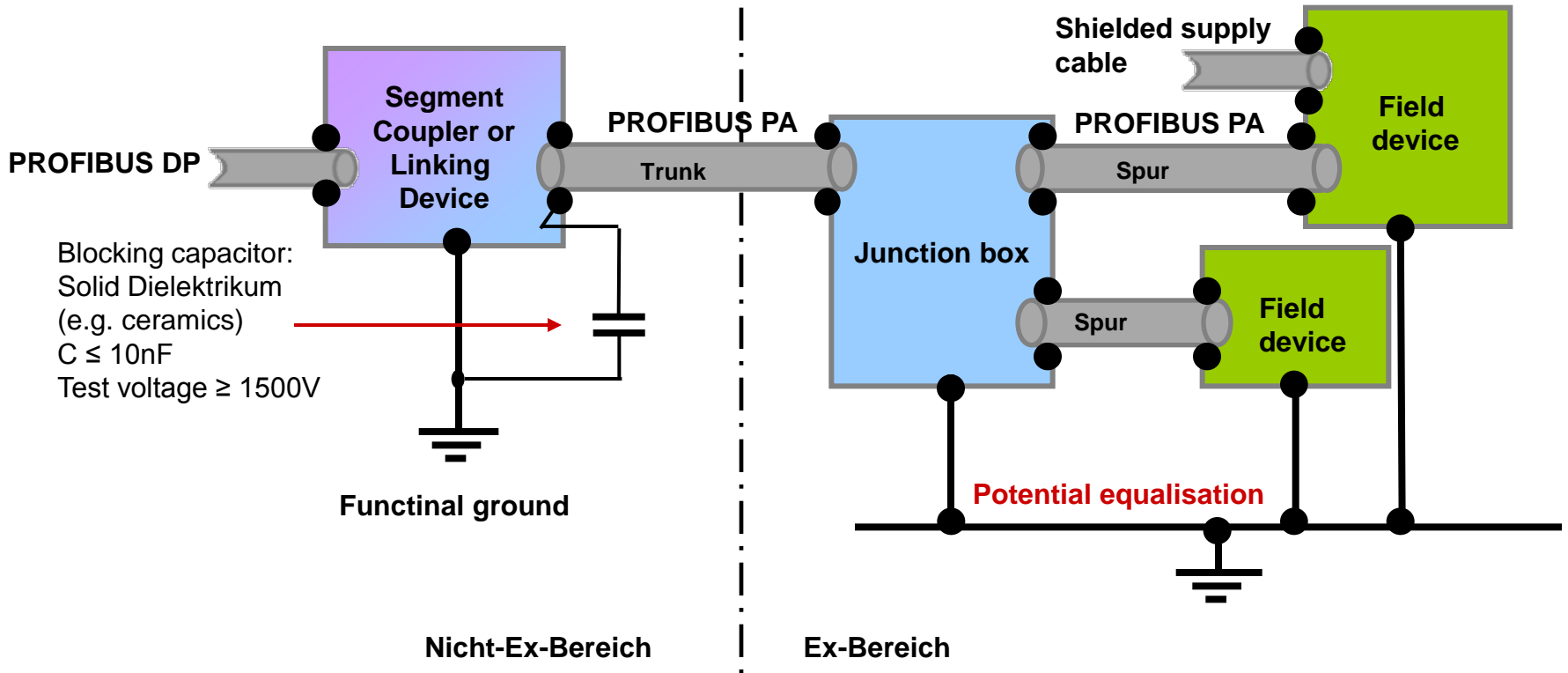

How to manage PA Field Devices?

PROFIBUS
PA device
management
is easy

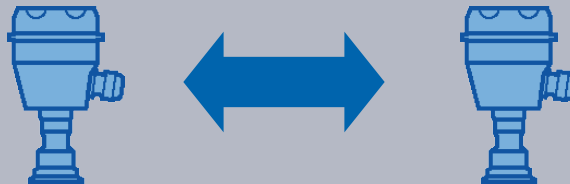

■ Field Device Management (6 Use Cases)

1. Device Update with a new (compatible) Device Description
2. Device Upgrade with a new DD with extended functionality
3. Device Exchange with same device type and same version
4. Device Exchange with same device type but different version
5. Device Exchange with device of different type or from different supplier using the profile GSD
6. Device Exchange with device of different type or from different supplier using PA Profile 3.02
7. Device-neutral Configuration



Device Update

Use of a new DD with extended functionality

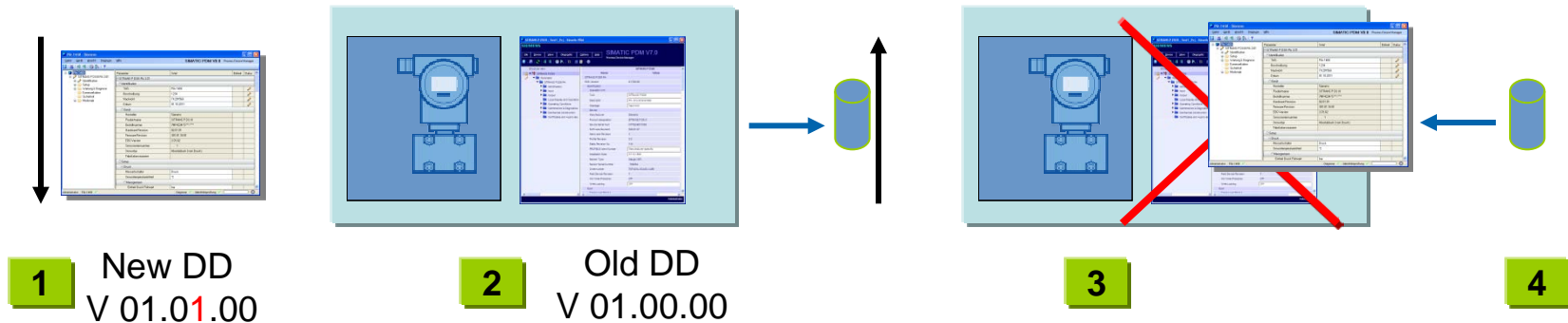

Step 1: Import the new DD

Step 2: Export the old parameter data

Step 3: Exchange the DD

Step 4: Import the new parameter data

Step 5: Compare with field device to complete parameter (not shown)



■ Device Exchange

Same device type and same version

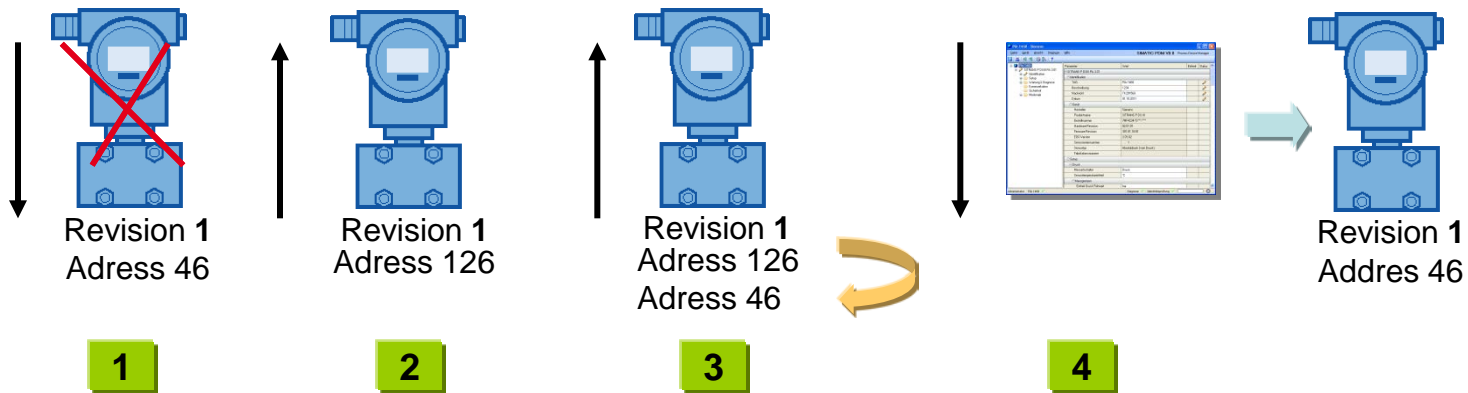

Step 1: Remove old/defect device (tagged with address 46)

Step 2: Install new device (tagged preliminary with address 126)

Step 3: Change address of new device to 46

Step 4: Upload parameter data



■ Device Exchange

Same device type but different versions

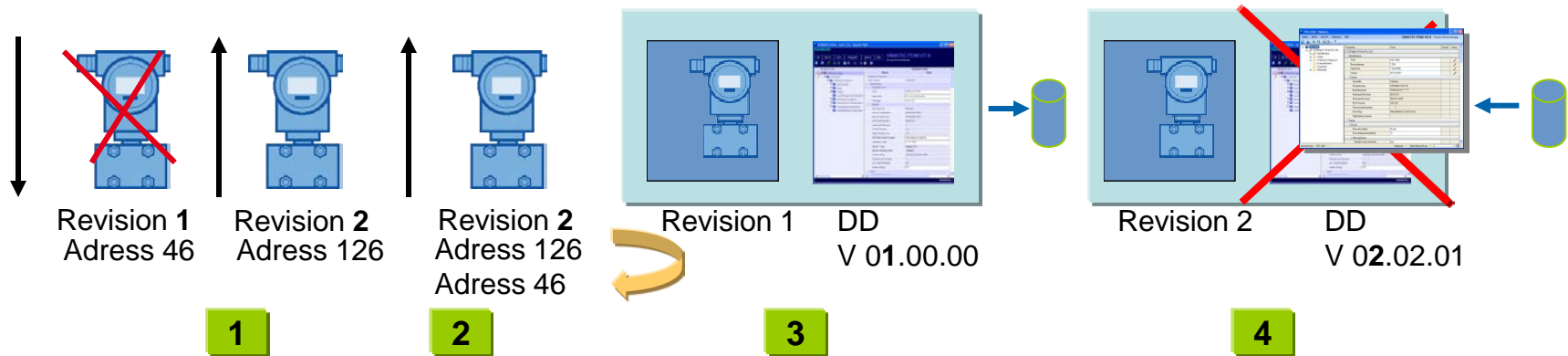

Step 1: Remove old/defect device (tagged with address 46)

Step 2: Install new device (Rev. 2, with address 126) and change address to 46

Step 3: Exchange DD and export parameter data

Step 4: Import parameter data

Step 5: Complete parameterization and upload parameters into the device (not shown)



Device Exchange

Device of different type or from different supplier - Use of profile GSD

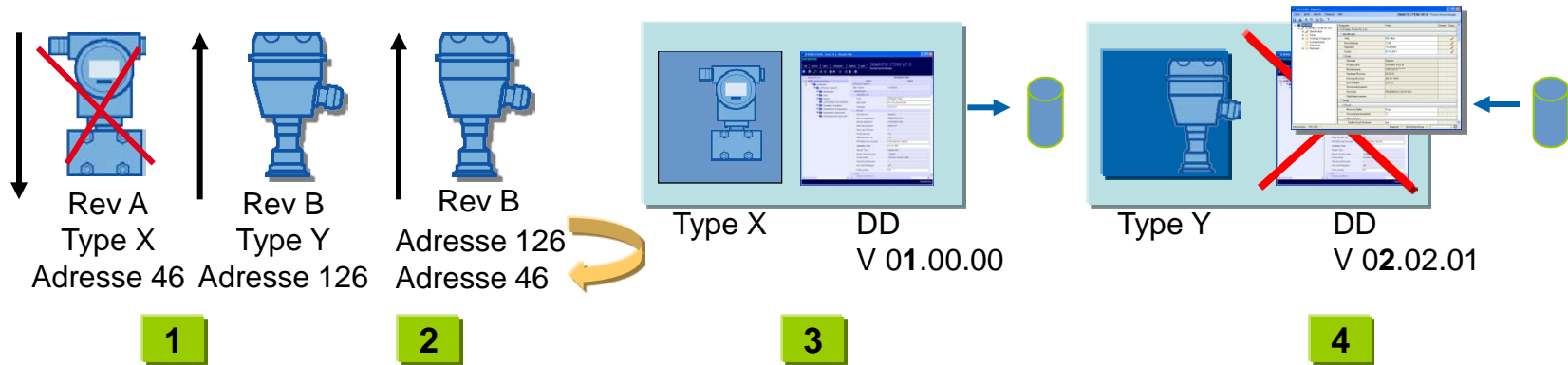

Step 1: Remove old or defect device (Rev A, Type X, tagged with address 46)

Step 2: Install new device (Rev B, Type Y, with address 126) and change to 46

Step 3: Export parameter data

Step 4: Exchange DD and import parameter data

Step 5: Complete parameterization and upload parameters into the device (not shown)



Device Exchange

Device of same type and same supplier/different GSD –
Use of PA Profile 3.02

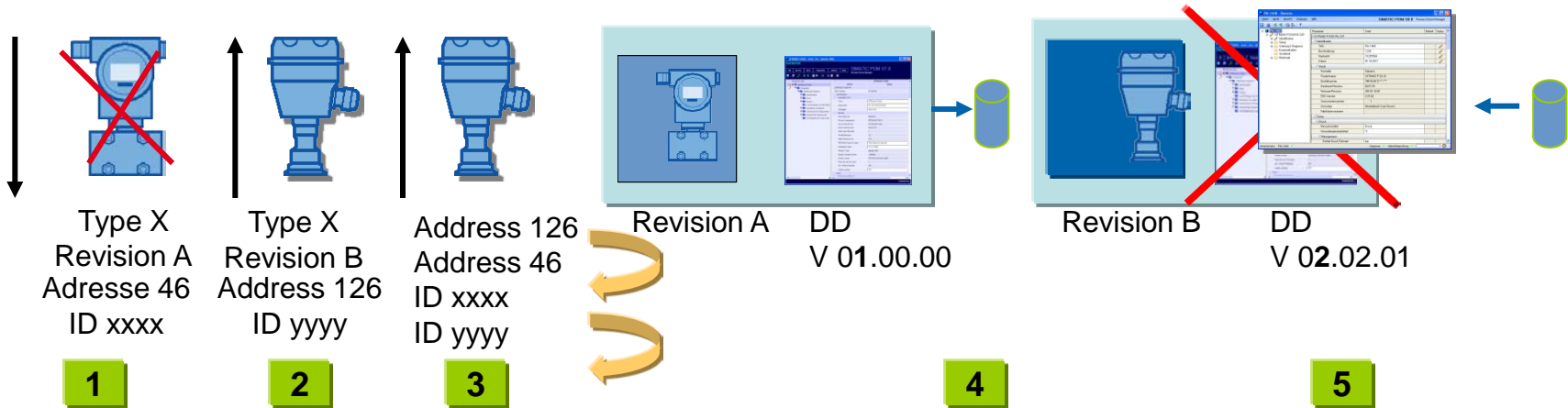

Step 1: Remove old/defect device (Type X, Rev A, address 46, ID XXXX)

Step 2: Install new device (Type X, Rev B, address 126, ID YYYY)

Step 3: Change adress to 46; ID is automatically changed to YYYY

Step 4: Export parameter data

Step 5: Exchange DD and import parameter data

Step 6: Complete parameterization and upload parameters into the device (not shown)



- For more information about diagnostic capabilities see also [“Diagnosis & Asset Management”](#).



Easy field device exchange

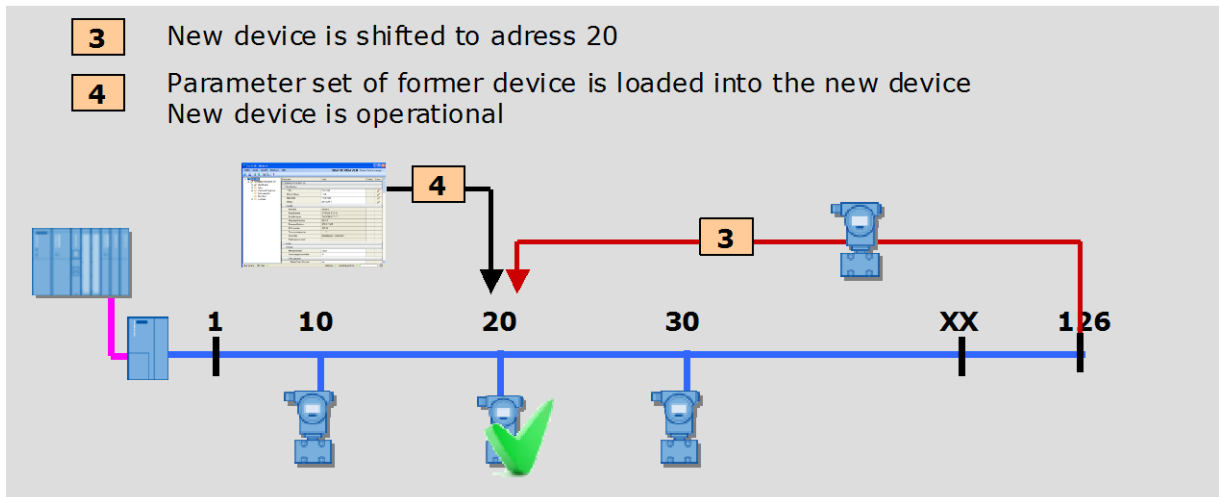
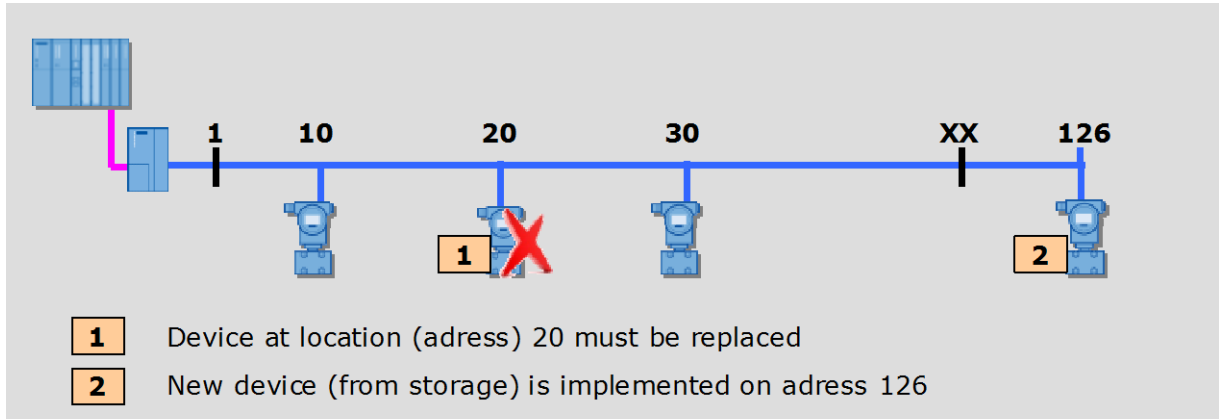

■ Service range in the address space

■ A „service range“ can be used for device-storing: keeping them live on the network but without implementing them in the PLC/DCS, for example to parameterize them via the bus.

■ Also, this devices can be kept as a backup for critical positions. As soon as an operational device fails, the backup device can be set to the corresponding address via the bus and build in at the correct position.

Default according to specification

Segment extent	32 devices
Address space	1 – 126
Typical addresses	1 for service-Tools, 126 for device exchange

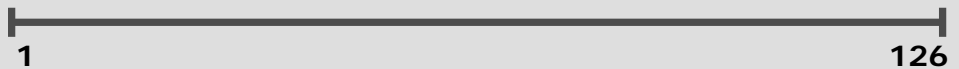

Re-setting for practical use (Installation of a service range)

Segment extent	32 devices
Address space	1 – 126
User space	1 – XX (XX freely selectable)
Space for service and device-storing	XX – 126 (Addresses for several devices)

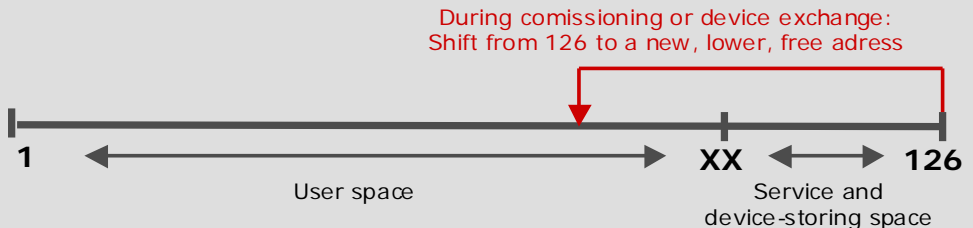

■ Device-neutral Configuration

- During plant installation and commissioning, the final field device assembly is often not yet known in detail
A “**device-neutral**” configuration is helpful in this case
- Conventional field devices are principally „device neutral“; because all feature the 4-20 mA “interface” and transmit one process value in one direction on one separate cable each
- Modern PROFIBUS PA field devices allow “device-neutral interfacing” by using the *Profile GSD*
- The *Profile GSD* acts as an identic interface for all PA devices with regard to transmission of defined vendor-neutral process values



■ Device-neutral communication configuration

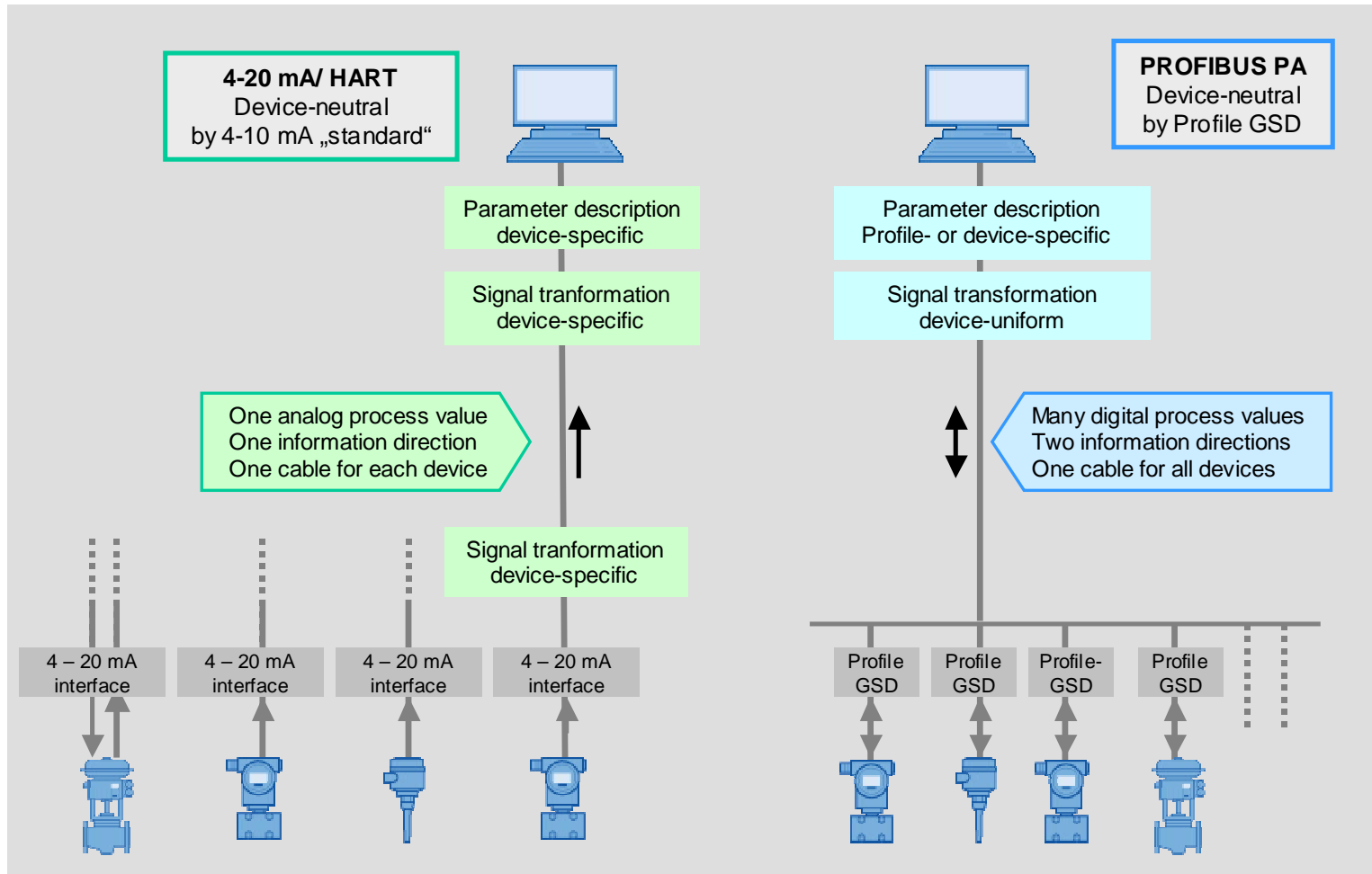

- GSD means **G**eneral **S**tation **D**escription
- A GSD is a text file defining all protocol information and cyclic data of a field device. It is used by the network configuration software
 - to identify the slave and
 - To set up the data exchange between the master and the slave during cyclic data exchange
- A Profile-GSD comprises all field device information which correspond to the content of a PROFIBUS profile, e.g. the “PA profile”.
- Therefore, all PROFIBUS PA devices dispose of an uniform Profile-GSD which is, in some aspects, comparable to the 4-20mA concept of conventional devices



How to use **PROFIBUS PA Diagnostics?**

PROFIBUS PA
provides an
intelligent
Diagnosis
Concept



■ Different tasks for plant operators and maintenance personnel

- **Process plant operators** have to control mainly availability and validity of process values, to ensure the process is running well.
- **Maintenance and service personnel** have to control the correct functioning of the devices and, if necessary, to locate and replace defect equipment.
- PROFIBUS PA (profile 3.02) diagnosis technology offers an efficient solution to select the right information for any of these groups and thus to avoid an overflow with information and alarms.
- The solution is based on the NAMUR NE 107 recommendation regarding the use of 6 different classes of alarms.



- PROFIBUS PA devices **1** transfer cyclically, along with the process value, a “value status” (condensed status) which carries easy-to-interpret information. The value status is categorized in one the 6 classes as specified in the NAMUR recommendation NE 107.

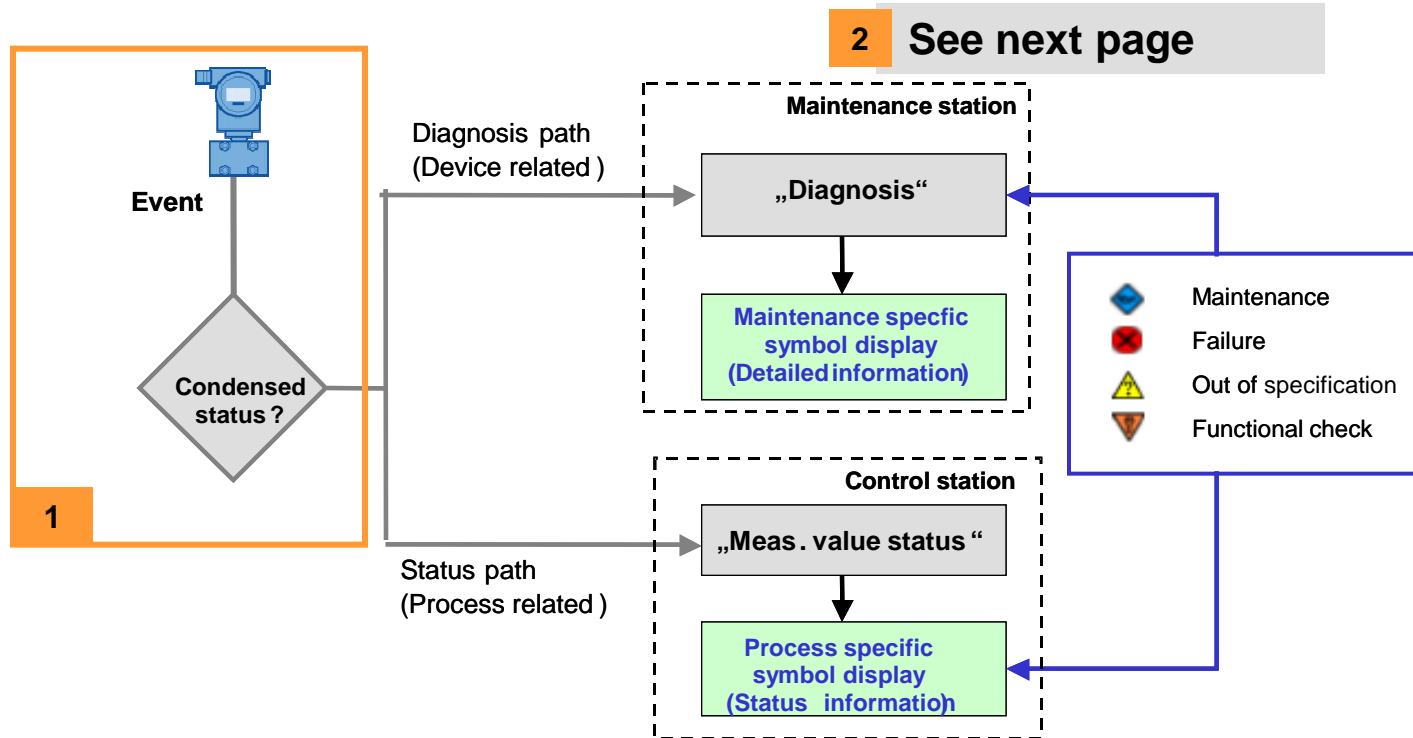

- The condensed status signal **2** is transmitted to the maintenance station (via “Diagnosis path”) and to the operator station (via “Status path”) where the signal is interpreted. Visualization is done by displaying symbols from NE 107: Typically just one symbol (ok or not ok) at the operator station, but more symbols at the maintenance station providing more details.

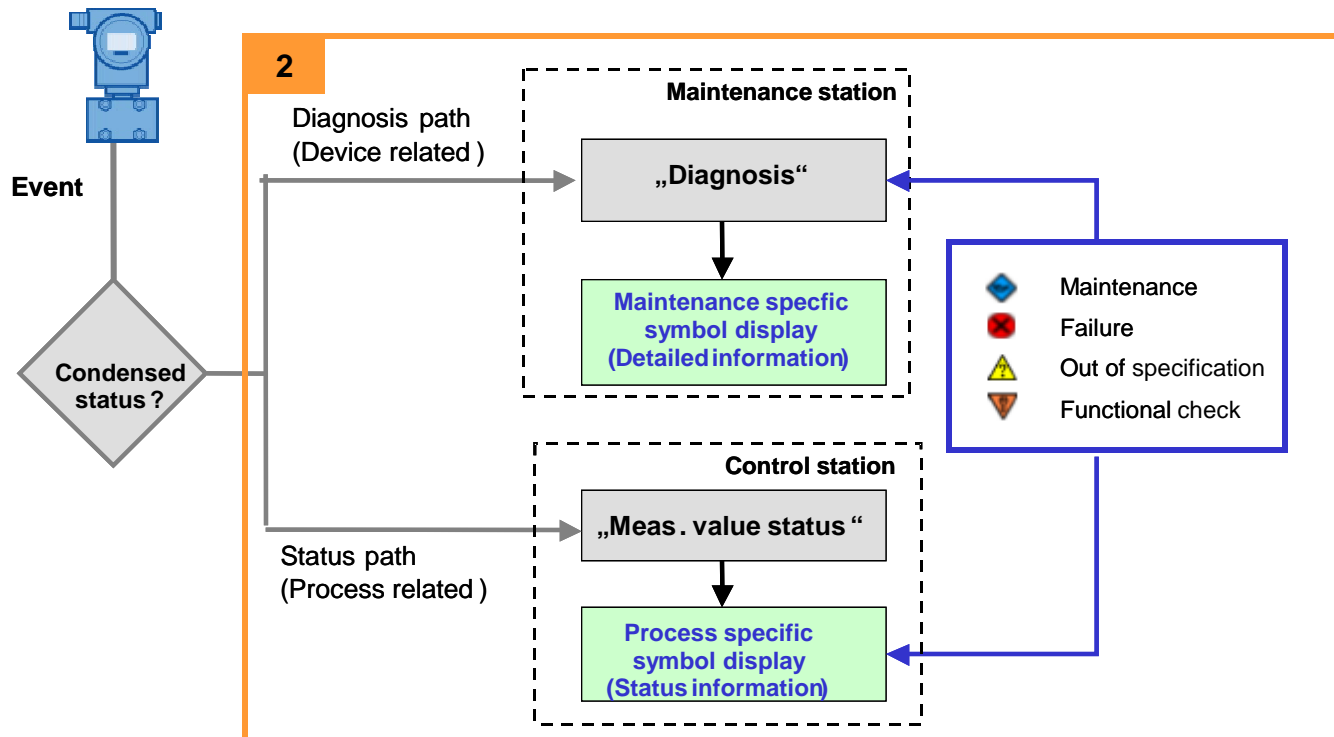

PROFIBUS Benefits

PROFIBUS
generates
multiple
benefits



- PROFIBUS is based on modularity and standard
 - The benefit: **Flexibility and Ease of use**
- The single communication protocol enables continuous, discrete, and safety-related processes to run on the same bus
 - The benefit: **No need for separate bus systems**
- Device profiles ensure compatible device behaviour at the bus
 - The benefit: **User can select the best suited device**



- Diagnostic data display sorted according to NAMUR NE 107
 - **The benefit: Operator can reliably detect the device status**

- The integrated redundancy ensures uninterrupted operation
 - **The benefit: High plant availability and efficiency**



■ Benefits for management and engineering staff

■ Plant Manager

- Lower overall plant costs
- Faster and more flexible production
- Better and constant product quality
- Safer plant operation
- Increased ROI
- More flexible production

■ Engineering staff

- Less wiring and less hardware needs
 - Faster engineering
 - Huge vendor choice
 - Easier commissioning
 - Simpler documentation
 - Modular and flexible solutions



■ Benefits for operators and plant

■ Operators staff

- Transparency down to the sensor
- Improved maintenance conditions
- Improved Asset Management
- More flexible production
- Shorter downtimes

■ Plant

- Advanced technology
- Easy migration
- Easier revamps
- Less expensive upgrades
- Longer useful life



PROFIBUS & PROFINET International (PI)

Organisation
Technologies
Support
Website



PI (PROFIBUS & PROFINET International)

Regional PI
Associations

PI Competence
Centers

PI Test
Laboratories

PI Training
Centers

Development and support of two technologies



Over **1,400** member companies worldwide

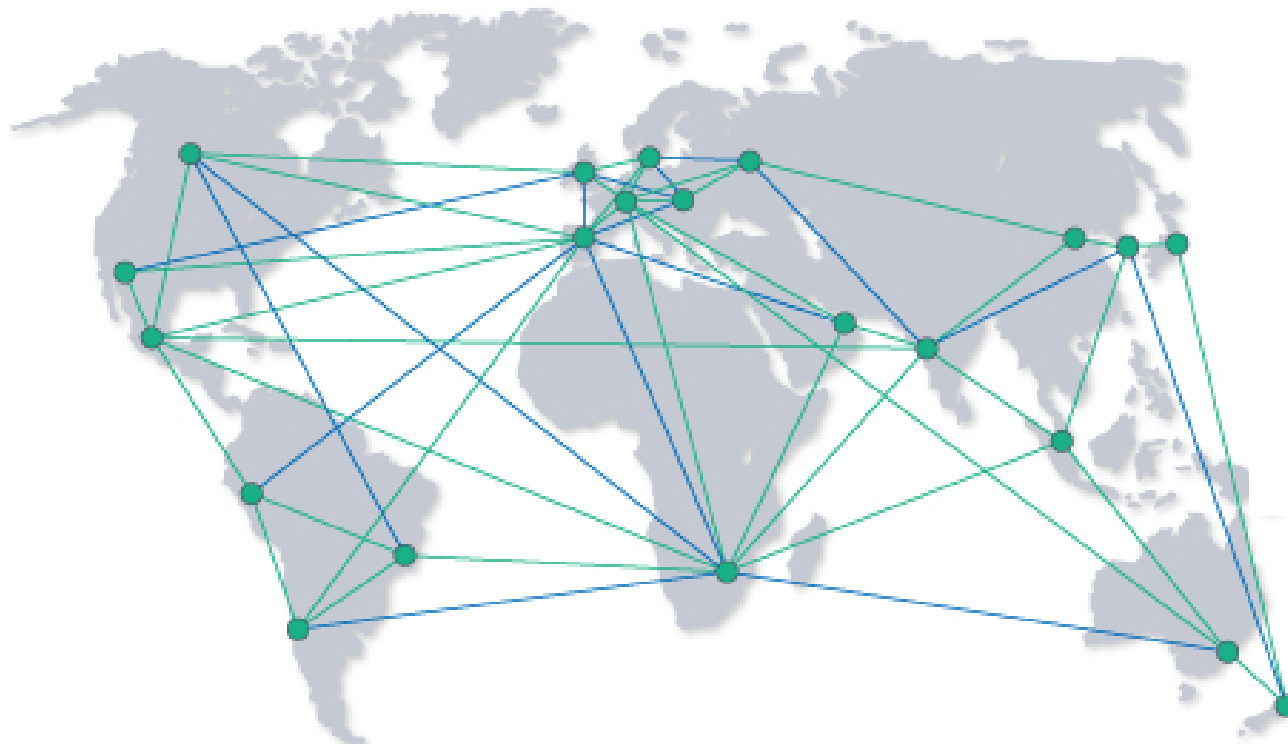

27

Regional PI
Associations
Your local contacts!

46

Competence Centers
Your support for
technical questions!

26

Trainig Centers
Learn from the best!

11

Test Laboratories
Your partners for
certification!



- With its background of more than 20 years and over 1400 member companies PROFIBUS & PROFINET International (PI) is the most influential interest group in industrial communication.
- The unique international network and experience of PI provide the member companies with a significant competitive edge.
- PI members benefit from the professional marketing of PROFIBUS and PROFINET at national and international levels.
- PI members have access to all technical documentation and can participate in further developments of technologies.
- The regional representatives provide worldwide support for realizing developments, training users and certifying products.



PROFIBUS is easy ...

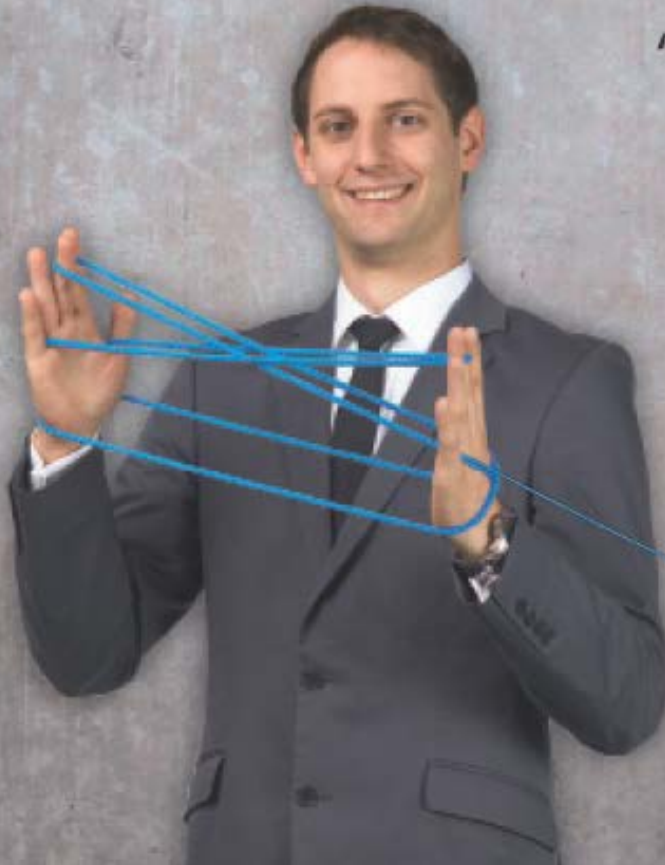

"The reason why PROFIBUS is so successful worldwide is that every day, this fieldbus proves itself and pays off. The decision for PROFIBUS is the decision for usability, flexibility, and security."

Steffen Ochsenreither,
Endress+Hauser Process Solutions AG,
Marketing Manager Fieldbus,
PI, Head of PROFIBUS PA Marketing





Share Our Vision for Automation



- Home
- Community
- Technology
- Products
- Training
- Events
- Press & Media
- Downloads

Username: Password:

- COMMUNITY
- TECHNOLOGY
- PRODUCTS
- TRAINING
- EVENTS
- PRESS & MEDIA
- DOWNLOADS



PI - The network of PROFInetworkers

"PI's global reach underpins the technological achievements of PROFIBUS and PROFINET, making them the "first choices" for automation users everywhere."

Michael J. Bryant
PI Deputy Chairman

[▶ See Video](#)

Product Finder

Our Product Finder lets you easily and quickly locate products conforming the PROFIBUS and PROFINET specifications.



[▶ Open product finder](#)

PROFITicker

Practical Aspects of PROFIBUS and PROFINET in Factory Automation

22 day(s) ago in [Trainings UNITED KINGDOM](#)

PROFIBUS-Praxisseminar (3 Tage) für Installation, Wartung, Instandhaltung, Service (Indu-Sol GmbH)

23 day(s) ago in [Trainings GERMANY](#)

[▶ All news](#)

PROFIBUS Diagnostics

SIEMENS



molex



COMSOFT

Is making the link.

Cutting-edge real-time COMSOFT solutions for PLCs



PROFIBUS Standardization

PROFIBUS is
standardized
worldwide



■ PROFIBUS is an open fieldbus, based on IEC standards

■ IEC 61158

*„Digital data communication for measurement and control –
Fieldbus for use in industrial control systems“*

IEC 61158 deals with the technologies. The individual fieldbuses are differentiated by the definition of “fieldbus protocol types”.

■ IEC 61784

*„Profile sets for continuous and discrete manufacturing
relative to fieldbus use in industrial control systems“*

IEC 61784 specifies in „Communication Profile Families“ which subsets of services and protocols of IEC 61158 (and other standards) are used by a given fieldbus system.



PROFIBUS and PROFINET in IEC 61158 and IEC 61784

Communication Profiles (CPF) in IEC 61784		"IEC 61158 protocol types" corresponding to CPFs		
CPF	Technology	Type Number	CP number	Technology
1	FF			
2	CIP			
3	PROFIBUS	3	CP 3/1	PB DP
		3	CP 3/2	PB PA
	10	CP 3/4	PN IO CC A	
	10	CP 3/5	PN IO CC B	
	10	CP 3/6	PN IO CC C	
9	HART	20	CP 9/1	HART
18		22		

For PROFIBUS and PROFINET the communication subsets are summarized in CPF 3.

PROFIBUS is type 3 and PROFINET type 10 of IEC 61158 protocol types. Actually, more than 20 protocol types exist.



PROFIBUS Implementation and Certification

Interfaces

Protocol

Application
Profiles



■ Without power supply from the bus cable

- Standard copper-based RS485 (RS485-IS) interface
- Data rates from 9.6 KBit/s to 12 MBit/s
- Modules are available from various manufactures

■ With power supply from the bus cable

- MBP (Manchester Coded Bus Powered) technology supplies current of 10-15 mA on the bus cable.
- Special chips draw the required operating energy from the MBP bus connection as supply voltage to the electronic components of the device.
- Chips also convert the digital signals of the protocol chip to the bus signal that is modulated to the energy supply.



■ For small quantities of devices: **Interface modules**

- PROFIBUS interface modules which implement the full bus protocol are available on the market.

■ For larger quantities of devices: **Protocol chips**

- Single chip solution with all functions integrated on the chip without a separate microcontroller (below, left)
- Chips combined with a microcontroller and firmware to provide the full implementation of the PROFIBUS protocol (mid)
- Protocol chips which already include a micro-controller inside the communication module (right)

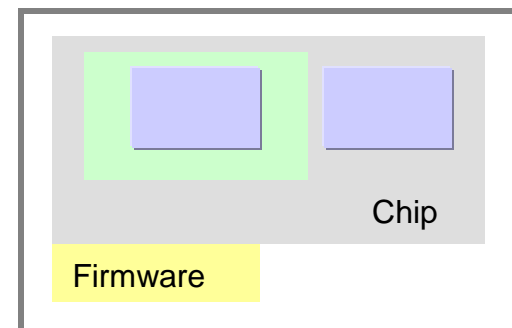
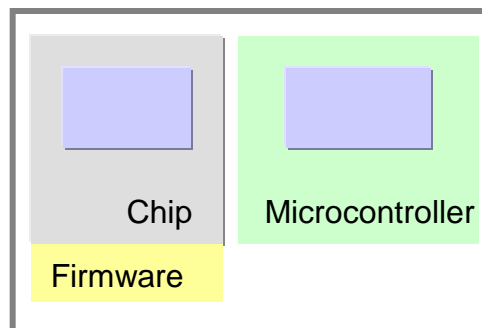
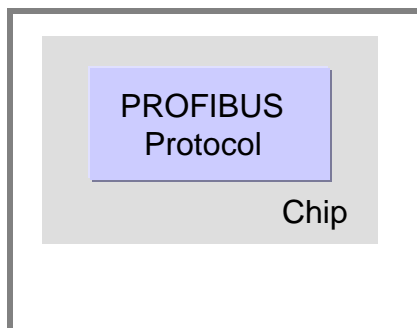

- Interpretation of data in a field device is generally handled by the user.
- User profiles (application profiles) represent the links between the PROFIBUS protocol and the actual application in a field device.
- Data formats, data access methods, parameterization and cyclical and acyclic communication diagnostics defined in the profile descriptions are implemented in software.
- Implementation is handled by the device manufacturers or by technology suppliers.



■ Device “Testing and Certification” procedure

■ Certification rules

- Uniform test measures and test process
- Comprehensible and documented results

■ Advantages

- Accreditation according to overall guidelines of PI ensures quality standard.
- Certification ensures interoperability and plant availability.

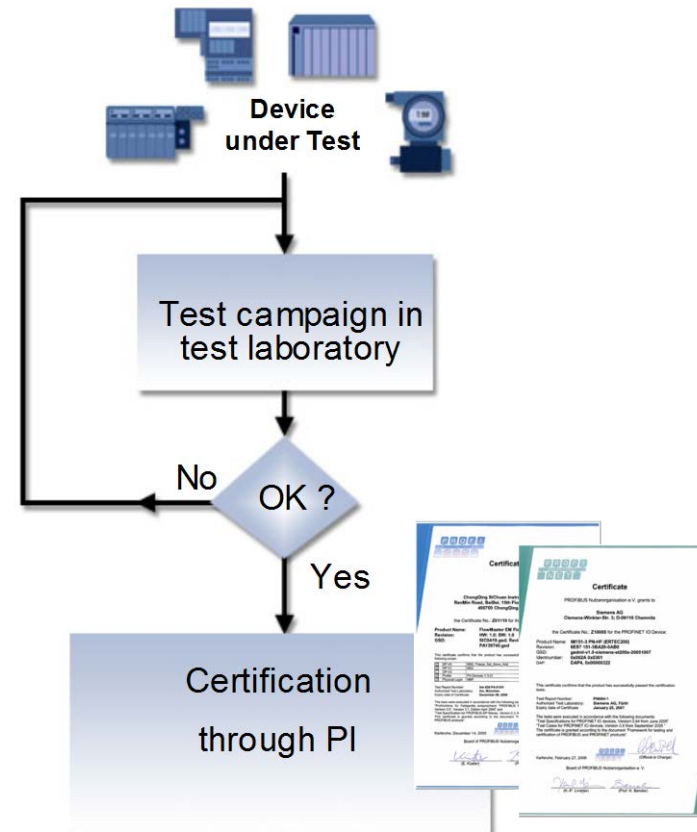

PROFIBUS Literature



■ Literature

- PROFIBUS System Description (PI)
- PROFINET System Description (PI)
- Introductory book: J Powell, H Vandelinde,
“On the road with the process fieldbus –
An introduction to PROFIBUS for process automation” (PI)
- Specialist book M. Popp: “The New Rapid Way to PROFIBUS“ (PI)
- Specialist book: Ch.Diedrich / Th. Bangemann: “Profibus PA”
Oldenbourg Industrieverlag (in German)



PROFIBUS

Success stories

**Manufacturing and
process industries**



■ Numerous „Case Studies“ are available on the PI Website, describing PROFIBUS applications in process and manufacturing industries:

- Car manufacturing
- Cross industry applications
- Energy, Pulp & Paper
- Food & Beverage
- Metal, Mining, Glass, Cement
- Oil & Gas
- Packing & Filling
- Paints, Chemical, Pharma
- Traffic, Infrastructure
- Water & Wastewater

[http://www.profibus.com/index.php?id=5013&pxdprofibusfilter_technology\[0\]=2&pxdprofibusfilter_technology\[1\]=3](http://www.profibus.com/index.php?id=5013&pxdprofibusfilter_technology[0]=2&pxdprofibusfilter_technology[1]=3)





